



INFRARED SAUNA SERIES

Installation and Operating Instructions

Tylö® Kiruna™ 3

TYLÖ

This Product is covered by:
US Patents No. 8,692,168
Canadian Patents No. 2,729,500
2,794,059 & 2,813,340
and other Patents Pending.



Sauna360 congratulates you on your decision to enjoy the finest sauna available...

Welcome to the growing family of Tylö® sauna owners.

Before you begin reviewing the manual, please take a moment to register your warranty. Doing so will assist us in contacting you for any important notification.

Prior to registering, you will need the serial number(s) located on the equipment.

To register, please go to <http://tylo.com/en-us/warranty>



FOR YOUR RECORDS

IR Room Model/Serial Number: _____

Control Model/Serial Number: _____

Date Purchased: _____

Dealer: _____

Address: _____

Phone Number: _____

Website/Email: _____

If questions arise regarding this product or this manual, please contact your authorized *Tylö* dealership. They are trained professionals who are familiar with the product as well as new sauna ownership concerns. Their expertise will facilitate the enjoyment of your new *Tylö* sauna.

IMPORTANT: SAUNA360 reserves the right to change specifications or design without notification and without incurring any obligation.

THIS PAGE IS INTENTIONALLY BLANK

Table of Contents

SECTION 1. BEFORE YOU BEGIN 1

SECTION 2. SAFETY INFORMATION 2

 2.1. CONSTRUCTION and INSTALLATION SAFETY 2

 2.2. USER and OPERATIONAL SAFETY 3

SECTION 3. INSTALLATION REQUIREMENTS 4

SECTION 4. PART LIST and TOOL REQUIREMENTS 5

SECTION 5. IR ROOM ASSEMBLY 7

SECTION 6. OPERATING the CONTROL 18

SECTION 7. Wi-Fi OPERATION (Optional) 19

SECTION 8. HOW TO TAKE A SAUNA 20

SECTION 9. MAINTENANCE 21

SECTION 10. TROUBLESHOOTING 21

SECTION 1. BEFORE YOU BEGIN

This manual is for installation and operation of a Tylö® Kiruna™ 3 sauna room mated with an Aspire control.



Tylö® Kiruna™ 3 Sauna Room
(IG 830 SH)



Aspire Control
(1601-39)

Figure 1.

Use these instructions when assembling the IR sauna room. For best results and for protection of product warranty, please read, understand and follow all safety information, safety placards, and installation and operating instructions prior to starting the installation process. When completed, leave these instructions with the owner.

If questions arise regarding this product or this manual, please contact your authorized Tylö dealership. They are trained professionals who are familiar with the product as well as new sauna ownership concerns. Their expertise will facilitate the enjoyment of your new **Tylö** sauna.

SECTION 2. SAFETY INFORMATION**2.1. CONSTRUCTION and INSTALLATION SAFETY**

WARNING - ELECTRIC SHOCK HAZARD: High voltage exists within this equipment. There are no user-serviceable parts within this equipment. Have the equipment installed and serviced only by qualified and licensed personnel in accordance with local and national codes.



WARNING - ELECTRIC SHOCK HAZARD: DO NOT install electrical receptacles inside the sauna room.



WARNING: If installing a fire sprinkler system inside the sauna room, ensure it is properly rated for sauna room temperatures.



CAUTION: When assembly is completed, ensure proper ventilation is provided and airflow is not restricted.



CAUTION: Loose electrical connections can cause heat damage to wires, terminal blocks and other components. Improper connections may void product warranty. Ensure all electrical connections are installed and inspected by qualified and licensed personnel.



IMPORTANT: The door to the sauna room must open outward, to the exterior of the sauna room.



IMPORTANT: DO NOT install a lock or mechanical locking device onto the door of the sauna room. If needed, use only a magnetic or spring-loaded catch mechanism that allows the door to open when pressed or pulled.



IMPORTANT: To prevent electrical shock, provide adequate electrical grounding to the electrical receptacle.



IMPORTANT: Do not install a shower in the sauna room.

NOTE: To protect product warranty, only qualified licensed personnel should perform installation and service to this equipment.

NOTE: A GFCI (Ground-Fault Circuit Interrupter) device is not required by NEC. Only install a GFCI if required by local codes, however, be aware this could cause nuisance electrical circuit trips during use of the product.

2.2. USER and OPERATIONAL SAFETY



WARNING: Prolonged exposure to elevated temperatures can induce hyperthermia. Hyperthermia occurs when internal body temperature reaches several degrees above normal (98.6°F). Symptoms of hyperthermia include an increase in body temperature, dizziness, lethargy, drowsiness, and fainting. Effects of hyperthermia include failure to perceive heat, failure to recognize the need to exit the room, unawareness of impending hazard, fetal damage in pregnant women, physical inability to exit the room and unconsciousness.



WARNING: DO NOT take a sauna if using alcohol, recreational drugs, or prescribed medication as these may greatly increase risk of hyperthermia, personal injury or death.



WARNING - FIRE HAZARD: DO NOT use the sauna room for drying clothes, bathing suits, towels, etc.



WARNING - FIRE HAZARD: IMMEDIATELY DISCONTINUE using the sauna if the walls or ceiling exhibit unusual discoloration and/or darken in color.



WARNING - HOT SURFACES: The IR emitters become hot during operation. Keep hair, head, hands, body, and appendages on the safe side of guard rails. Provide close visual supervision to children, minors, and vulnerable individuals while in use.



IMPORTANT: If pregnant or a person in poor health, consult with a physician before using sauna.



IMPORTANT: DO NOT exercise, play or roughhouse while using the sauna. Be safe and respectful of everyone.



IMPORTANT: Keep children, minors, and vulnerable individuals safe. Be a responsible sauna user. When needed, provide operating instructions to those less experienced. Keep operation of the sauna safe for yourself and others to enjoy.



IMPORTANT: Do not spray water on infrared emitters. Use of water on infrared emitters may cause damage and will void the warranty.

NOTE: Inspect the sauna regularly. Check for maintenance of the floor, control, and benches. Replace wood surfaces should any show signs of deterioration.

SECTION 3. INSTALLATION REQUIREMENTS

To ensure safe use of the IR sauna room, verify the following criteria are met:

- At least three (3) adults are required for the assembly and installation of the room.
- Ensure all electrical wiring is installed in accordance with NEC, state, and local codes.
- The IR sauna room is designed to operate on 120 Volts AC (standard household current).
- The IG 830 SH IR room will require 20 amp service. Install electrical wire that is rated appropriately to meet or exceed the *Maximum Current Load* from the electrical panel to the receptacle. For safety, do not use extension cords, under-sized, or inappropriately rated wiring.

Model Number	Maximum Current Load	Wire Rating (Minimum)
IG 830BH	20 Amp	#2 12AWG +Gr

- A 120 VAC dedicated circuit is recommended to avoid unnecessary tripping of the assigned circuit breaker.
- Ensure the circuit breaker is rated to *ONLY* meet the design limit of the *Maximum Current Load*. Do not install an oversized/over-rated circuit breaker. Do not exceed the safety rating of the *Maximum Current Load*.
- Install a NEMA 5-20R amp rated electrical receptacle.

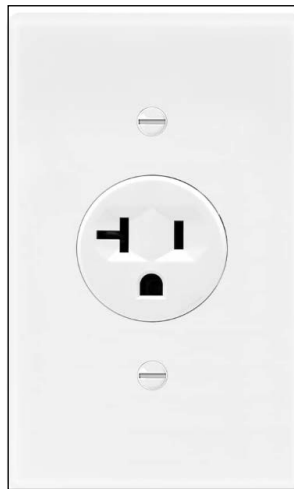

5-20R (20 Amp) Receptacle

Figure 2.

- Do not operate the IR sauna room should the power cord or connector become damaged or adversely discolored.
- Ventilation must comply with instructions provided in this manual.

SECTION 4. PART LIST and TOOL REQUIREMENTS

PART LIST

Before starting the assembly process, inspect packaging and verify contents.

Each box label indicates the model of the IR room and serial number. The label also provides a brief description of the box contents.

The hardware package with each room includes a T20 Torx bit.

- **Box #1:** Floor, ceiling, bench skirt, bench and door handle.
- **Box #2:** Left and right walls and left and right front edge trim.
- **Box #3:** Front walls.
- **Box #4:** Back walls.

6000-306

RM IR Tylo Kiruna 3

LOW EMR/EF V1

SL# CSF33ABS830TL-V1-5195



6000-306

RM IR Tylo Kiruna 3

LOW EMR/EF V1

SL# CSF33ABS830TL-V1-5195



6000-306

RM IR Tylo Kiruna 3

LOW EMR/EF V1

SL# CSF33ABS830TL-V1-5195



6000-306

RM IR Tylo Kiruna 3

LOW EMR/EF V1

SL# CSF33ABS830TL-V1-5195



Should it be necessary to contact your dealer or technical support, record the model and serial numbers from each box.

Box Number	_____
Serial Number	_____
Model Number	_____
Box Number	_____
Serial Number	_____
Model Number	_____
Box Number	_____
Serial Number	_____
Model Number	_____
Box Number	_____
Serial Number	_____
Model Number	_____

TOOL REQUIREMENTS

- Box knife
- #2 Phillips Head Screw Driver
- T20 Torx Drive
- Bubble level
- Two (2) glass lifting suction cups
- Non-marring rubber mallet
- Common glue stick
- Roll of blue painter's tape

SECTION 5. IR ROOM ASSEMBLY

Use these instructions for assembling a 3-person IR sauna room.

LAYING THE FLOOR PANEL

1. Place the floor panel on a flat, level surface, between 3 and 6 inches away from nearby walls, and no more than 5 feet from the dedicated electrical receptacle. **DO NOT** connect the power cord into the receptacle at this time.
2. Position the floor panel so the IR floor emitters are oriented towards the front of the IR room.
3. Using a bubble level, check the floor panel for level. If necessary, use wooden shims beneath the floor panel to make level.
4. Ensure all cables and connectors attached to the floor panel are pulled in away from the edges.
5. At the front right corner of the footer trim, ensure the lighting cable is connected and tucked away inside the cable chase of the floor. Ensure no cables are visible beyond the right edge of the footer.
6. Place the power cord on the outside of the floor panel.



Figure 3. Laying the Floor Panel

INSTALLING BACK RIGHT WALL SECTION

The back wall is in two (2) sections (Labeled #1 and #2)

7. Place the hangers of the back *Right* wall section into the mating hangers located on the back *Right* edge of the floor panel.
8. Hold the back *Right* wall in place until back *Left* wall section is installed.

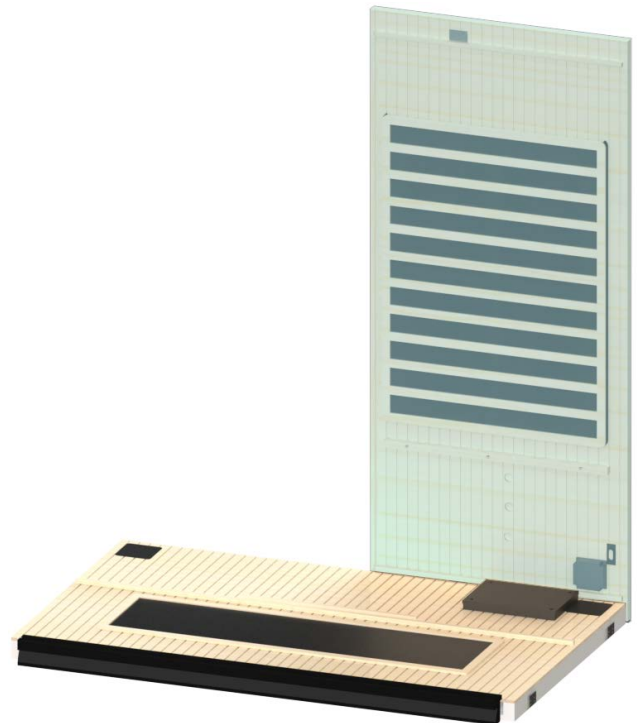

Figure 4. Installing Back Right Wall Section

INSTALLING BACK LEFT WALL SECTION

9. Place the hangers of the back *Left* wall section into the mating hangers located on the back *Left* side of the floor panel.
10. Lift up the *Left* wall section and slide the edge brackets into the mating brackets located on the edge of the back *Right* wall section.
11. Hold the back wall assembly in place until left wall section is installed.

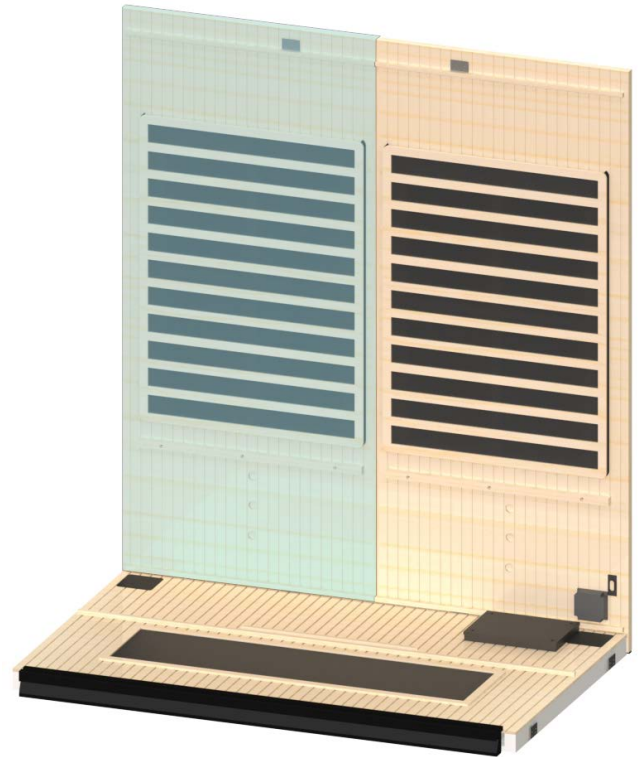

Figure 5. Installing Back Left Wall Section

INSTALLING LEFT WALL SECTION

12. Place the hangers of the left wall section into the mating hangers located on the left edge of the floor panel.
13. Lift up the left wall and slide the edge brackets into the mating brackets located on the back wall.



Figure 6. Installing Left Wall Section

INSTALLING RIGHT WALL SECTION

14. Place the hangers of the right wall section into the mating hangers located on the right side of the floor panel.
15. Lift up the right wall and slide the edge brackets into the mating brackets located on the back wall.
16. When the wall panels are mated correctly, verify the top edges where the corners meet are flat and flush.

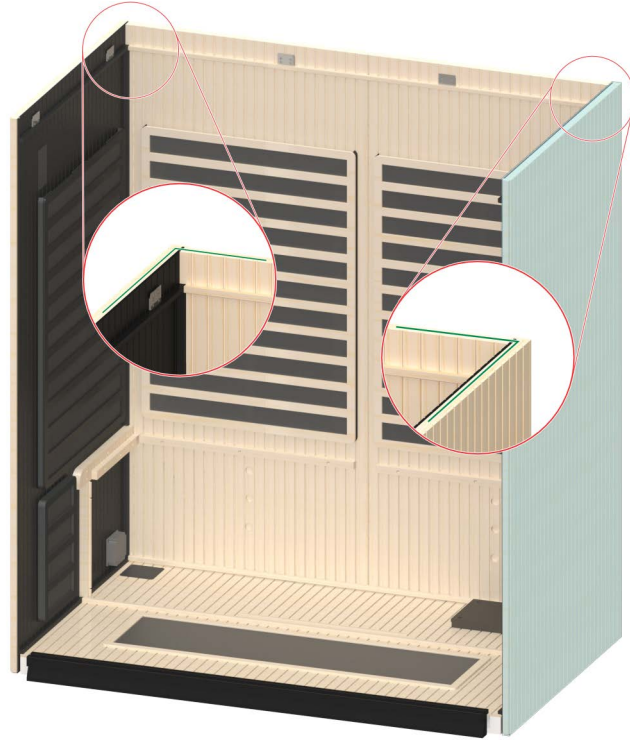

Figure 7. Installing Right Wall Section

17. Install the left front edge trim to the edge of the left wall.
 - TIP: *** Leave the right front edge trim uninstalled until after the benches are installed.
18. *Install right front edge trim to the edge of the right wall.

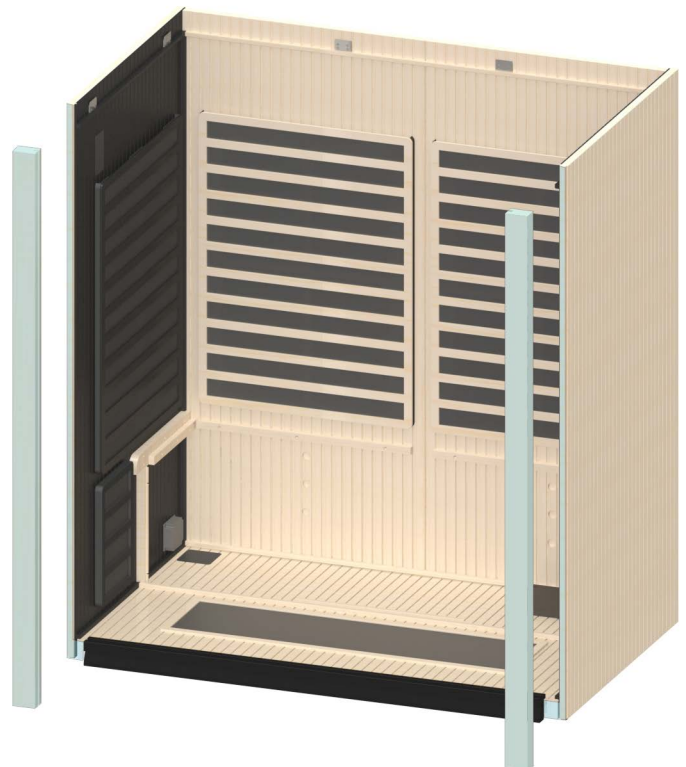

Figure 8. Installing Front Edge Trim

INSTALLING BENCH SKIRT

19. Insert the bench skirt between the left and right wall sections.
20. Pull loose cables towards the back wall, away from the bench skirt.
21. Slide the bench skirt all the way to the floor.

NOTE: At this time, you may alternatively latch the bench skirt to the left and right walls. See Step 35 on page 12.

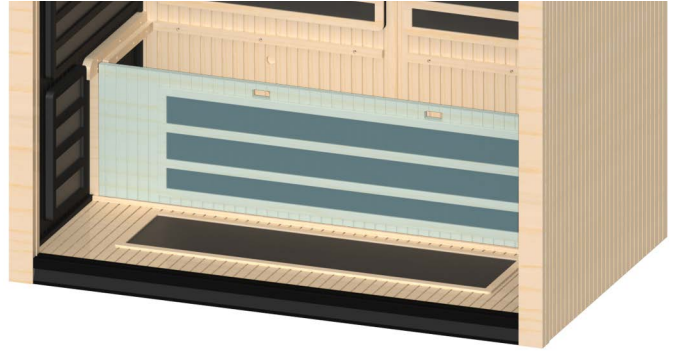

Figure 9. Installing Bench Skirt

INSTALLING BENCH SEAT

22. With the power junction box facing towards you, slide the bench seat down against the back wall.
23. Tilt the bench seat up against the back wall.
24. Install the right front edge trim if not already installed.

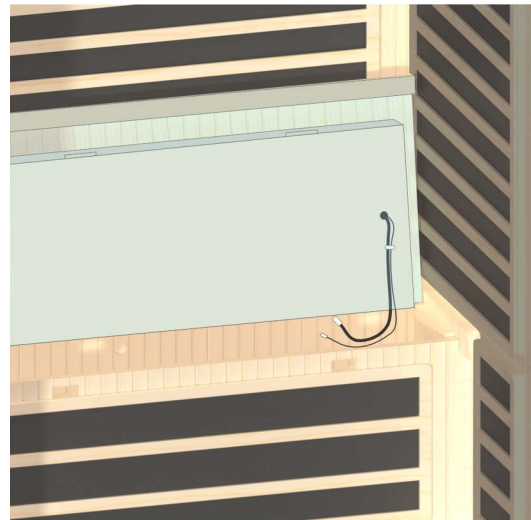

Figure 10. Installing Bench Seat

ELECTRICAL CONNECTIONS - Beneath Bench, Right Corner

25. Connect the #4 cable from the distribution plate to the back wall #4 cable.
26. Connect the #5 cable from the distribution plate to the back wall #5 cable.
27. Connect the R1 cable from the distribution plate to the right wall junction box R1 cable.

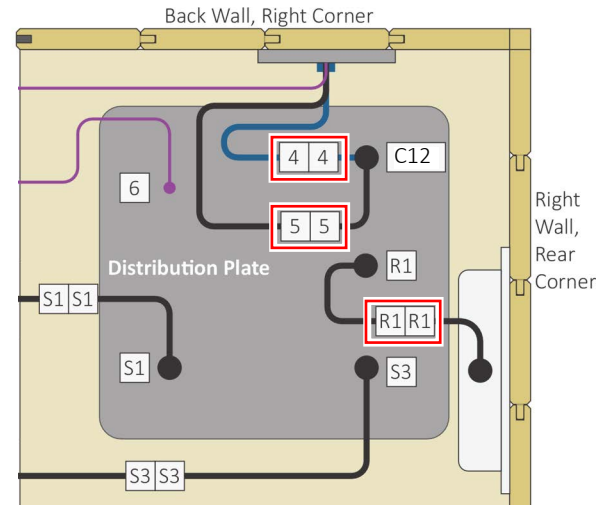

Figure 11. Beneath Bench, Right Corner

28. Connect the #6 cable from the back wall to the #6 cable splitter from the distribution plate.
29. Connect the bench seat #6 cable to the #6 cable splitter from the distribution plate.
30. Connect the #S1 cable from the distribution plate to the bench seat #S1 cable.
31. Connect the #S3 cable from the distribution plate to the bench skirt #S3 cable.

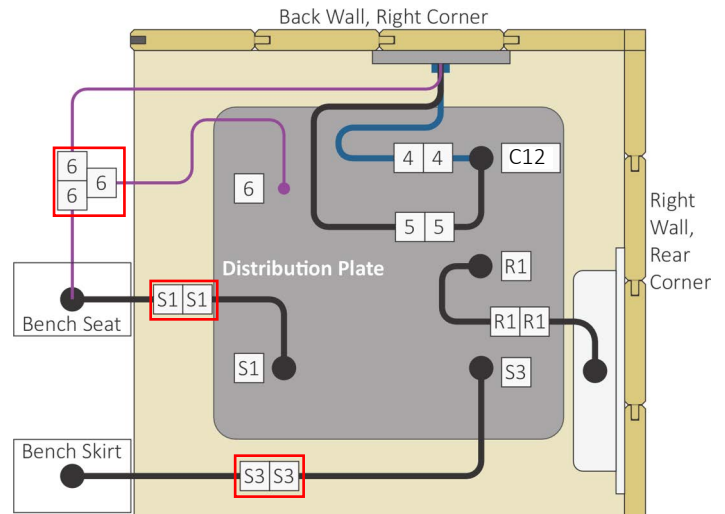

Figure 12. Connecting Bench Seat and Skirt

ELECTRICAL CONNECTIONS - Beneath Bench, Left Corner

32. Connect the #L1 cable from the distribution plate to the left wall #L1 cable.
33. Connect the #B1 cable from the distribution plate to the back wall #B1 cable.
34. Connect the #B2 cable from the distribution plate to the back wall #B2 cable.

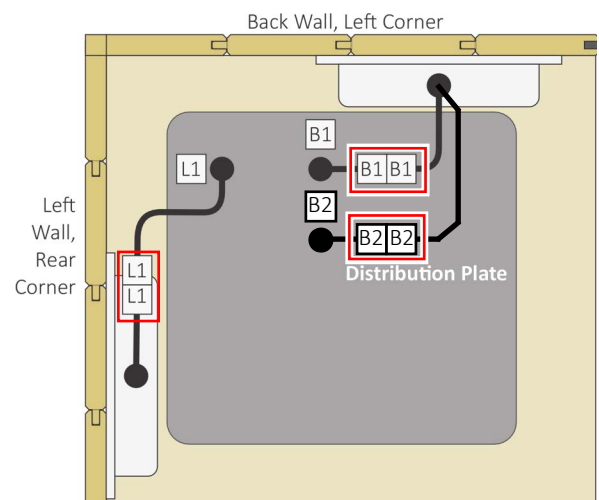

Figure 13. Beneath Bench, Left Corner

35. From the master control box, turn **ON** the power switch.

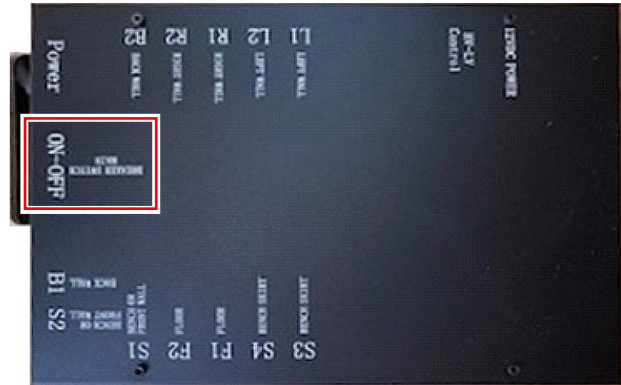

Figure 14.

36. Latch the bench skirt to the left and right walls.

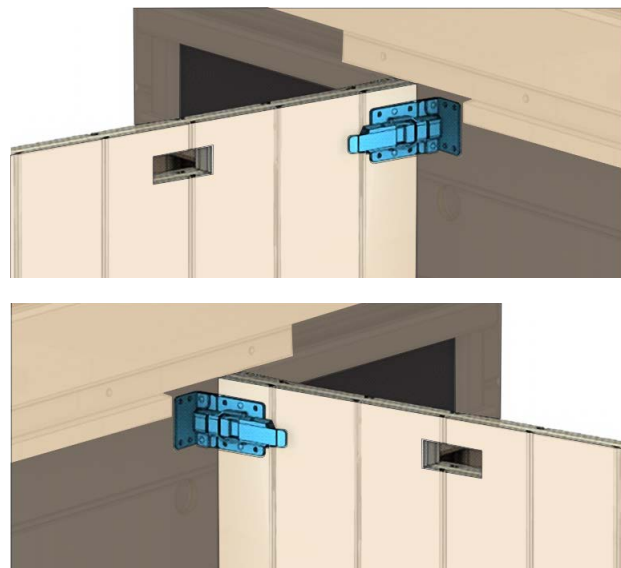

Figure 15.

37. Tuck the back edge of the bench seat beneath the back wall heater guard, then push the bench all the way to the back wall.

38. Drop the bench seat into place on the bench skirt. If necessary, use the openingsglass lifting suction cup located on the bench skirt to reach in and wedge the bench seat into place.

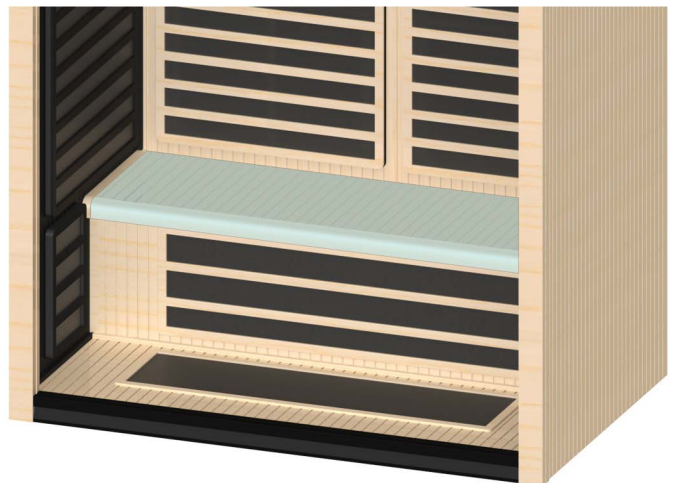

Figure 16.

INSTALLING THE SINGLE GLASS PANE

NOTE: Use glass lifting suction cups when lifting and aligning glass panes.

39. Orient the single glass pane on the left side of the room with the attached door seal mating surface facing outward.

NOTE: To help orientation, the words “Tempered Glass” are etched along the bottom edge of all glass panels.

The U-gasket material goes along the top and bottom edges of glass pane, then into the U-channels of the footer and ceiling.

TIP: * Using a glue stick, apply a thin layer of adhesive along the bottom inside and outside edges of glass. Then follow the instruction in the step below while adhering the bottom U-gasket in place.

40. *Align the door edge of U-gasket flush with the edge of the glass.
41. Carefully lift and place the bottom edge of the glass pane into the U-channel of the footer.
42. Align the left edge of the glass pane with the U-channel cut into the edge of the left corner trim and carefully press into place.
43. Re-verify the orientation of the door seal mating surface is facing outward.

TIP: ** Using blue painter’s tape, temporarily secure the top portion of the glass pane to the left corner trim.

44. **Hold the glass pane in place while preparing for installation of the door assembly.

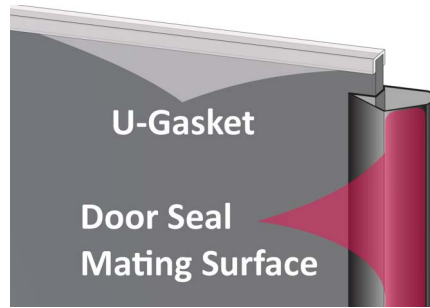

Figure 17. Single Glass Pane Orientation & U-Gasket

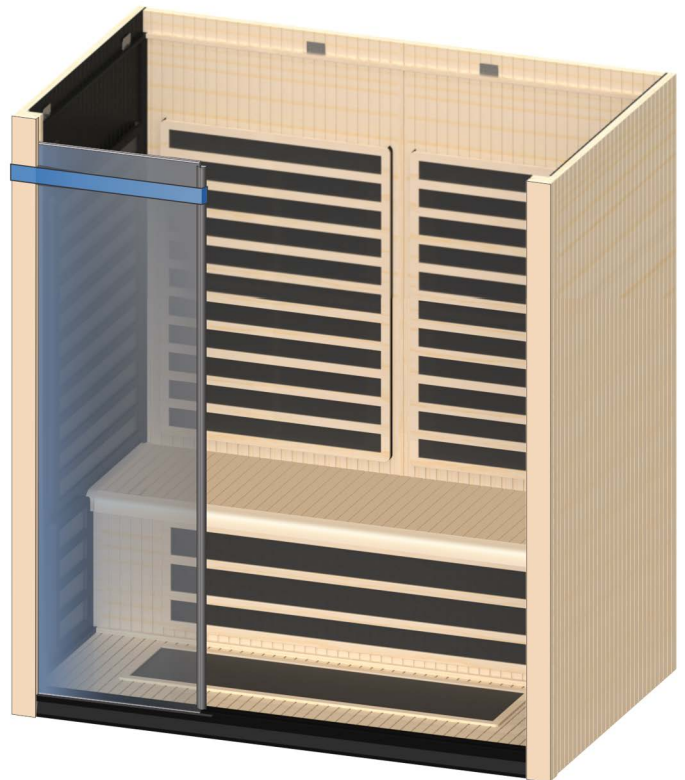

Figure 18. Installing the Single Panel



HEAVY OBJECT: The door assembly is extremely heavy and fragile. It is best practice to have three (3) people assist during installation.

DOOR SEAL ORIENTATION

45. Orient the door assembly so that the attached door seal will mate correctly with the door seal on the single glass pane.

The single pane door seal faces outward, away from the sauna room, while the seal on the edge of the door faces inward towards the room.

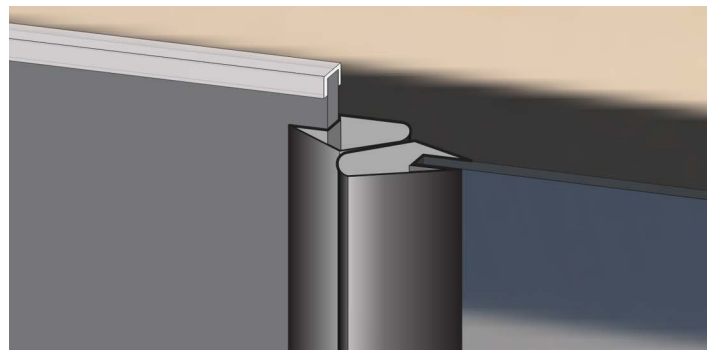
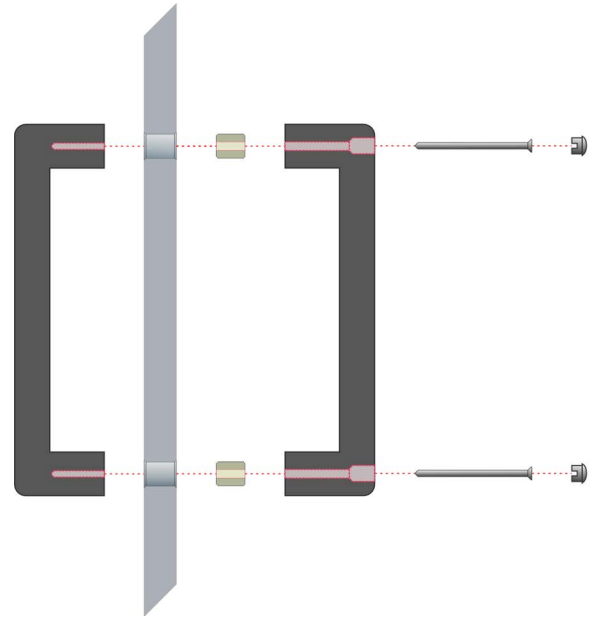

Figure 19. Door Seal Orientation

INSTALLING DOOR HANDLE

46. Arrange the door handles and hardware as shown in Figure 20.
47. Place the door handles on either side of the glass door, aligning with the holes in the glass.
48. Install the spacers into the holes in the glass.
49. Using the two (2) M4 x 100mm Phillips head screws included in the kit, attach the door handles to the glass door. Install screws by hand with a screw driver DO NOT USE a power tool.
50. Install the caps into the ends of the handle screw holes.

**Figure 20. Installing Door Handle****INSTALLING THE DOOR ASSEMBLY**

The U-gasket material goes along the top and bottom edges of glass pane, then into the U-channels of the footer and ceiling.

TIP: * Using a glue stick, apply a thin layer of adhesive along the bottom inside and outside edges of glass. Then follow the instruction in the step below while adhering the bottom U-gasket in place.

51. *Align the door edge of U-gasket flush with the edge of the glass.
- TIP: ****Angle the door assembly such that the lower-left corner of the glass pane enters the footer U-channel first.
52. **Carefully lift and place the bottom edge of the glass pane into the U-channel of the footer.
53. Align edge of the glass pane with the channel cut into the edge of wall panel and carefully press into place.
54. Re-verify the orientation of the attached door seal correctly mates with the single pane seal.

**Figure 21. Installing the Door Assembly**

PREPARING THE CEILING

NOTE: The ceiling is heavy and handling is awkward. It is best to stand inside the sauna room while guiding the ceiling into position.

55. From the top of the left, right, and back wall sections, Pull the ends of the cables out and away, over the outside edges.
56. Place two (2) foam blocks on top of the front left and right corners.
57. Slowly lower the ceiling into place, starting from the back of the room first, then onto the foam blocks at the front.

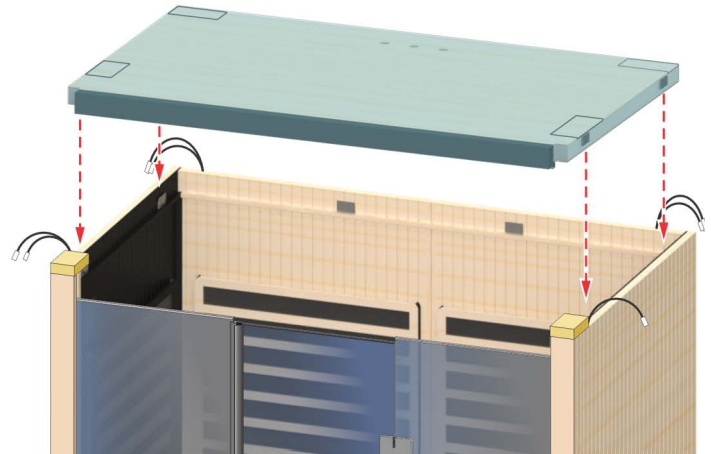

Figure 22. Preparing the Ceiling

INSTALLING THE CEILING

58. Ensure the cables located along the top edges of the walls are clear of the pinch points.
59. Remove the two (2) foam blocks.
60. Carefully guide edges of the two (2) glass panes into the channel on the metal edge of the ceiling.
61. Guide the ceiling down onto the mating brackets on the left, right, and back wall sections.

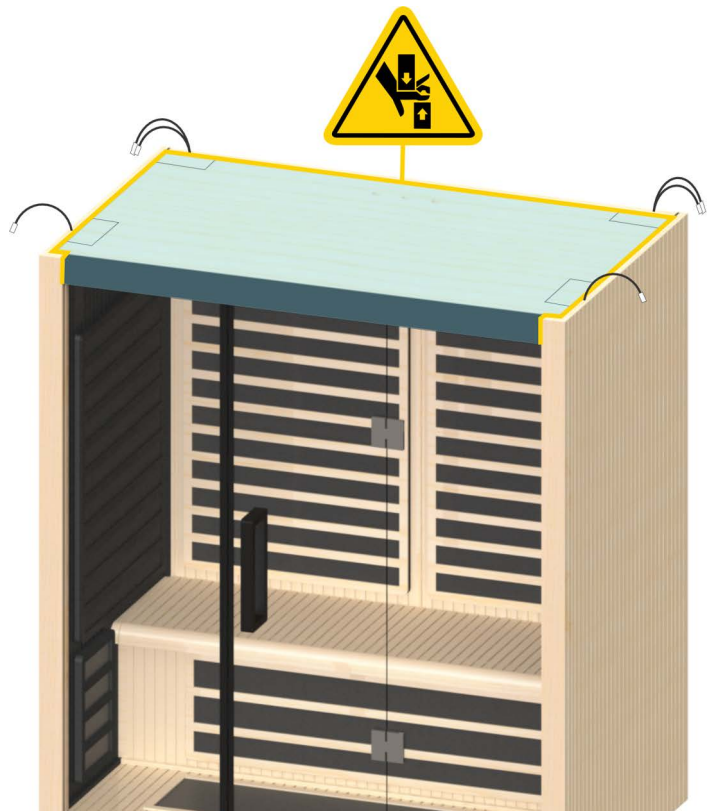

Figure 23. Installing the Ceiling

INSTALLING CORNER STIFFENING BRACKETS

NOTE: The brackets provided with this kit may have a different appearance than what is shown in Figure 24.

- 62. If pilot holes were not provided on the top corners, it may be necessary to pre-drill holes for installation of the bracket screws.
 - Press the corner trim tight into the corner and use the brackets as a hole placement guide.
- 63. Using the screws provided, install the corner stiffening brackets included with this kit.

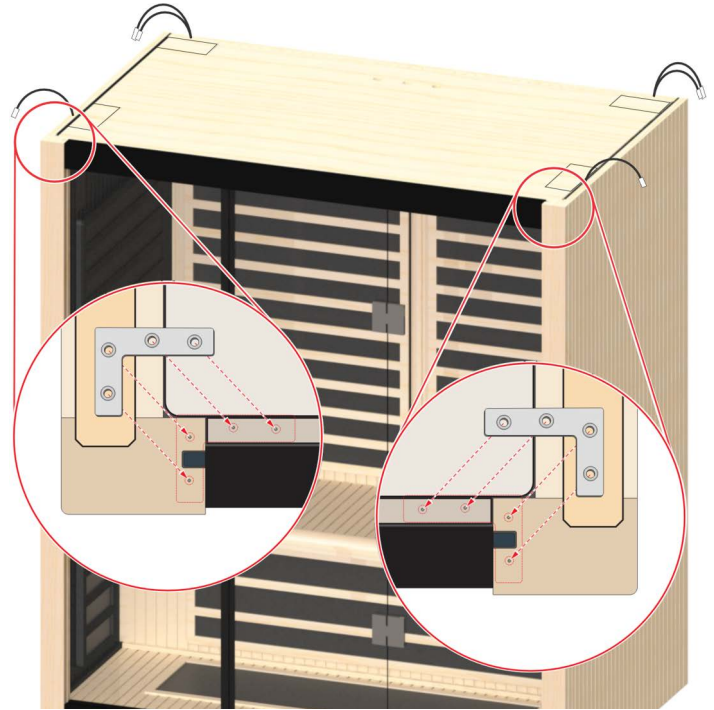

Figure 24. Installing Corner Stiffening Brackets

- 64. From the top of the ceiling, open the four (4) hatches located on the front, rear left, and front, rear right.

ELECTRICAL CONNECTIONS - Ceiling, Back Right Corner

- 65. Fish out the four (4) cables from the hatch.
- 66. Connect the back wall #4 cable to the #4 ceiling cable.
- 67. Connect the back wall #5 cable to the #5 ceiling cable.
- 68. Connect the back wall #6 cable to the the #6 ceiling cable.
- 69. Connect the back wall #7 cable to the #7 ceiling cable.
- 70. Dress the wall cables into the trench.
- 71. Close the hatch.

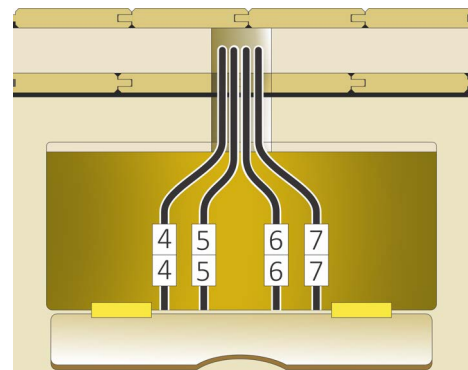

Figure 25. Ceiling, Back Right Corner

ELECTRICAL CONNECTIONS - Ceiling, Front Left Corner

- 72. Fish out the two (2) cables from the hatch.
- 73. Connect left wall #7 cable to #7 ceiling cable.
- 74. Connect left wall RJ11 (M) cable to RJ11 (F) ceiling cable.
- 75. Dress the wall cables into the trench.
- 76. Close the hatch.

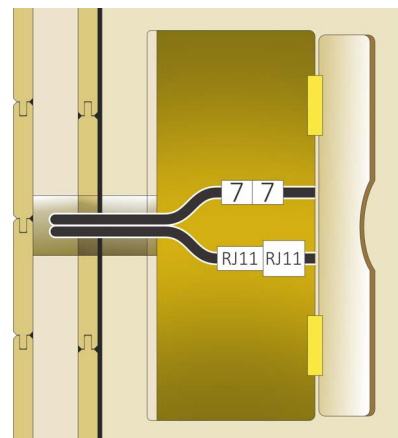

Figure 26. Ceiling, Front Left Corner

ELECTRICAL CONNECTIONS - Ceiling, Back Left Corner

77. Fish out the one (1) cable from the hatch.
78. Connect left wall #7 cable to #7 ceiling cable.
79. Dress the wall cable into the trench.
80. Close the hatch.

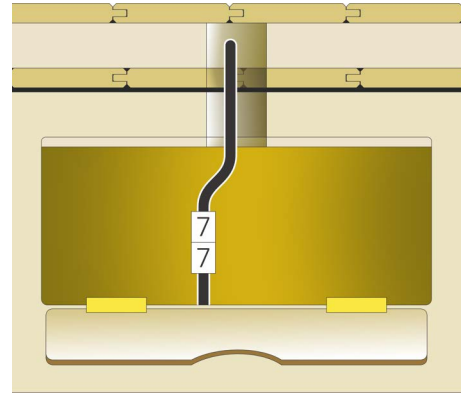

Figure 27. Ceiling, Back Left Corner

ELECTRICAL CONNECTIONS - Ceiling, Front Right Corner

81. Fish out the one (1) cable from the hatch.
82. Connect left wall #7 cable to #7 ceiling cable.
83. Dress the wall cable into the trench.
84. Close the hatch.

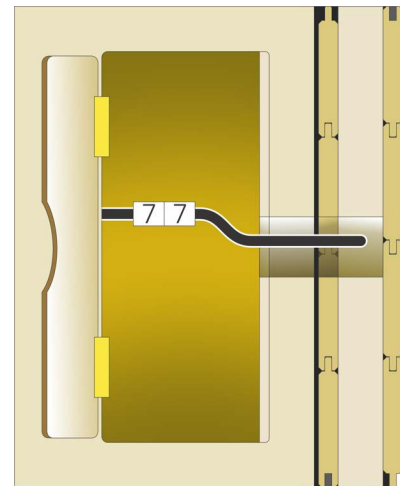

Figure 28. Ceiling, Front Right Corner

CONNECTING POWER

Depending on the corresponding sauna room model, connect the sauna room power cord into either a 15 amp / 5-15R or 20 amp / 5-20R receptacle.

NOTE: Ensure the IR sauna room is connected to a dedicated circuit that is configured for the correct electrical rating.



WARNING: Incorrectly connecting the IR sauna room into a shared circuit will cause poor performance, circuit breaker tripping, and overheating of electrical wiring.

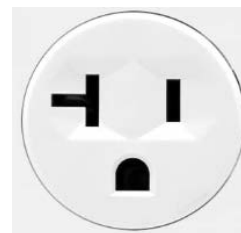

5-20R Receptacle



20 Amp Plug

Figure 29. Connecting Power

SECTION 6. OPERATING the CONTROL

The instructions provided here are for operating an Aspire control.

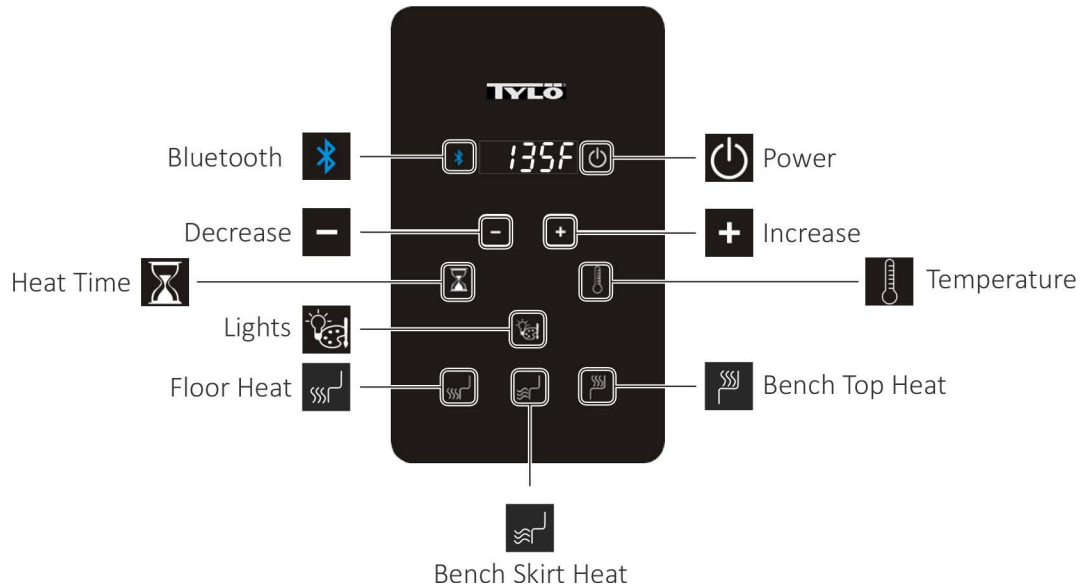

Figure 30. Control Icons

APPLYING POWER

Press the **Power** icon once. The default settings for the temperature is 149°F, the bath time is 60 minutes. These settings are adjustable (as described below) from 119° to 149°. Length of the sauna can be set from 0 to 60 minutes. Any changes are remembered by the control for your next bath. Should power to the sauna room be lost then restored, the settings will return to their default values.

Press the **Bench Top Heat** icon to turn on/off the bench heat.

Press the **Bench Skirt Heat** icon to turn on/off the skirt heat.

Press the **Floor Heat** icon to turn on/off the floor heat.

SETTING DURATION and TEMPERATURE

Press the **Heat Time** icon for time, then press the **Increase** or **Decrease** icon to increase or decrease the amount of minutes (in 15 minute increments) to the desired setting. The maximum setting is 60 minutes.

Press the **Temperature** icon to toggle the display temperature between **C** or **F** and then press/hold the **Increase** or **Decrease** icon to increase or decrease the amount of heat to the desired setting. The maximum setting is 149°F (65°C).

LIGHTING OPERATION

Press the **Lights** icon to cycle through lighting options.

Sequence of colors are- White- Red- Green- Blue- Yellow- Aqua- Purple- Rotation of colors- Off.

Make a color choice, then set brightness. The brightness adjustment is available on the display for three (3) seconds. Press either the **Increase** or **Decrease** icon to increase or decrease the brightness. Brightness settings available are 25, 50, 75, and 100%.

Press and hold the **Lights** icon for three (3) seconds to turn off the light. Alternatively, cycle through the colors to turn off.

BLUETOOTH® AUDIO (Optional)

The Aspire control is capable of operating **ONLY** a Bluetooth package purchased with the system. Press the **Bluetooth** icon to turn on or off the system.



IMPORTANT: Most Apple® products are rated to operate within a temperature range of 32°F to 95°F. The warranty for the Apple product may become null and void if operated inside a sauna room where the temperature exceeds the manufacturers maximum recommended temperature rating.

SECTION 7. Wi-Fi OPERATION (Optional)

The Aspire control is Wi-Fi (2.4GHz only) compatible. Download the *Tylö App* and install onto your smart phone.

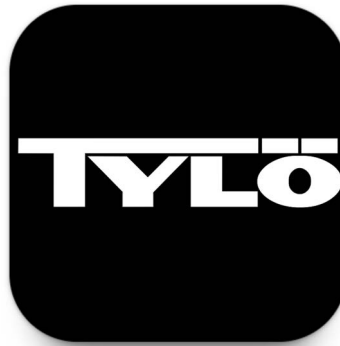

Figure 31.

REGISTER A NEW ACCOUNT

1. When the *Tylö App* opens for the first time, it first provides the option to *Register* or *Login with an Existing Account*.
2. Select the *Register* option and follow the prompts to complete the registration process.
3. A valid email address or a mobile phone number is required to complete registration.

PAIRING INFORMATION

1. Follow the App instructions for pairing to a device.
2. Press and hold the **Bluetooth** icon until an audible “beep” is heard.

SECTION 8. HOW TO TAKE A SAUNA

- Devote adequate time to completely relax while taking a sauna bath.
- Before using the sauna, avoid eating a large meal and intake of alcoholic beverages.
- If taking prescribed medications and/or under the care of a physician, consult with them prior to using the sauna.
- Remove clothing and jewelry. If preferred, wear loose-fitting clothes.
- For best results, take a warm shower before the sauna, then apply a towel loosely about the body. Enter the sauna wet without padding down to dry.
- Enjoy listening to audio books or music while relaxing in the sauna. Depending on preference, sit or lay down on the bench, adjust the ceiling vent to provide adequate air circulation.
- If desired, add colored light therapy to the experience.
- **DO NOT** smoke, exercise or drink alcoholic beverages while in the sauna room.
- An IR sauna produces infrared wavelengths that are absorbed by skin tissue in a span of 10-15 minutes. It is not necessary to wait until the sauna has reached maximum temperature. The absorption rate is the same whether the room is warming up or at its maximum temperature.
- After ten (10) minutes or when perspiration begins, exit from the sauna, relax in the dressing area, followed by a cool shower.
- Stay hydrated, drinking water is best.
- The allotted cool down time should equal the amount of time occupying the sauna. The amount of time varies by the individual.
- Step back into the sauna room and remain for five (5) or ten (10) minutes.
- Repeat the cycle two (2) or three (3) more times. End with a brisk shower, rinsing in cool water.
- When you have completed the final sauna session, turn off power to the sauna.
- Open the door and use a clean damp cloth to wipe down the walls, bench and floor areas.
- Enjoy a final shower or bath to cool down. Bask in the special sauna “after glow”. Partake in a healthy snack and/or a cool, refreshing drink.
- Put on clothing only after perspiration has stopped and the body is completely dry.

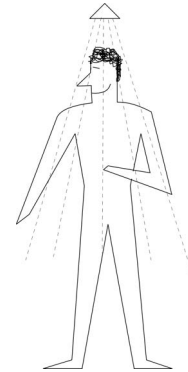

Shower



Sauna Bathe

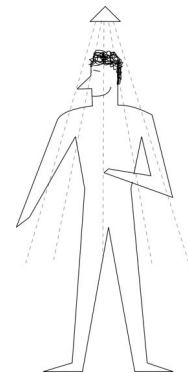

Shower

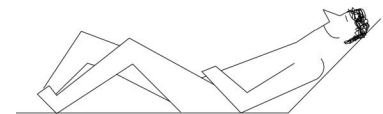

Rest/Relax



Hydrate

SECTION 9. MAINTENANCE

Inspect the sauna room at the end of each day of use to ensure the control and system are turned OFF.

Keep the sauna room clean and odor free. Use towels or mats on benches and floor as perspiration otherwise penetrates the soft wood. To clean and remove perspiration stains, use soap or detergent in warm water, best applied with a scrub brush. Badly soiled surfaces may require sanding. Sand paper wrapped around a wooden block works well.

Air out the sauna often by keeping the door and vent open when the sauna is not in use. Saunas that are used daily should be wiped down at least once a week to keep them clean and air fresh.

Inspect benches and supporting structure annually for potential deterioration due to age, dry rot, and neglect. Avoid hazards and personal injury by immediately replacing boards that show signs of deterioration.

SECTION 10. TROUBLESHOOTING**Control Touch Pad Indicators Not Illuminated**

Access the three (3) hatches on top of the ceiling. Verify all of the cable connectors are locked and engaged between the associated cable harnesses.

Ensure the power cord is connected to the correct dedicated electrical receptacle.

Ensure there is no damage to the electrical receptacle and power cord.

Ensure the dedicated circuit breaker for the sauna is not tripped (electrical power is available at the receptacle).

Raise the bench seat and examine the condition of the circuit breaker on the main controller. Ensure the circuit breaker on the controller has not tripped. Ensure the power switch on the main controller is turned ON.

Room Not Heating

Ensure the power cord is connected to the correct dedicated electrical receptacle.

Ensure there is no damage to the electrical receptacle and power cord.

Ensure the dedicated circuit breaker for the sauna is not tripped (electrical power is available at the receptacle).

Raise the bench seat and examine the condition of the circuit breaker on the main controller. Ensure the circuit breaker on the controller has not tripped. Ensure the power switch on the main controller is turned ON.

Ensure the IR temperature set point is greater than the ambient sauna room temperature (controller demands heat).

Door Rubbing or Binding

Ensure the walls, ceiling, and floor of the sauna room are assembled properly.

Using a bubble level, ensure the floor of the sauna room is laying flat and level. If necessary insert (a) small wooden shim(s) beneath the floor of the sauna room to adjust for level.

If necessary, please contact your local dealer or outlet you purchased your product for questions and support. Prior to calling, please have the Model and Type number available.

©2024 Sauna360 Inc.

The Bluetooth® word mark and logos are registered trademarks owned by Bluetooth SIG, Inc. and any use of such marks by Sauna360 is under license.

Apple® is a registered trademark of Apple Inc.

Tylö® is a registered trademark of Sauna360.

SAUNA360
HELP PEOPLE LIVE BETTER

