



INFRASAUNA SERIES

Installation and Operating Instructions

Tylö® Kiruna Hybrid™ 3

TYLÖ

THIS PAGE IS INTENTIONALLY BLANK



Sauna360 congratulates you on your decision to enjoy the finest sauna available...

Welcome to the growing family of Tylö® sauna owners.

Before you begin reviewing the manual, please take a moment to register your warranty. Doing so will assist us in contacting you for any important notification.

Prior to registering, you will need the serial number(s) located on the equipment.

To register, please go to <http://tylo.com/en-us/warranty>



FOR YOUR RECORDS

IS Room Model/Serial Number: _____

Sauna Heater Model/Serial Number: _____

Control Model/Serial Number: _____

Contact Box Model/Serial Number: _____

Date Purchased: _____

Dealer: _____

Address: _____

Phone Number: _____

Website/Email: _____

If questions arise regarding this product or this manual, please contact your authorized Tylö dealership. They are trained professionals who are familiar with the product as well as new sauna ownership concerns. Their expertise will facilitate the enjoyment of your new **Tylö** sauna.

IMPORTANT: SAUNA360 reserves the right to change specifications or design without notification and without incurring any obligation.

THIS PAGE IS INTENTIONALLY BLANK

Table of Contents

SECTION 1. BEFORE YOU BEGIN 1

SECTION 2. SAFETY INFORMATION 2

 2.1. CONSTRUCTION and INSTALLATION SAFETY 2

 2.2. USER and OPERATIONAL SAFETY 3

SECTION 3. INSTALLATION REQUIREMENTS 4

SECTION 4. PART LIST and TOOL REQUIREMENTS 5

SECTION 5. SAUNA ROOM ASSEMBLY 7

SECTION 6. ELECTRICAL HOOK-UP 19

SECTION 7. CONTROL INSTALLATION 22

SECTION 8. CONTROL QUICK GUIDE 23

SECTION 9. PLACING SAUNA ROCKS 24

SECTION 10. HOW TO TAKE A SAUNA 25

SECTION 11. MAINTENANCE 26

SECTION 12. TROUBLESHOOTING 26

 12.1. PRE-HEAT MODE 26

 12.2. SENSOR NOT DETECTED 27

 12.3. HIGH LIMIT ERROR 27

 12.4. DOOR OPEN 28

 12.5. JUMPER ERROR 28

 12.6. INFORMATION 28

SECTION 1. BEFORE YOU BEGIN

This manual is for installation and operation of an Tylö® Kiruna Hybrid™ 3 sauna room mated with a Sense UB heater (1802-60-1902), a Bliss IS control (1601-53) and a CB22-1 (1201-22-1) contactor (CB) box.



Tylö® Kiruna Hybrid™ 3 Sauna Room



Sense UB Heater
(1802-60-1902)

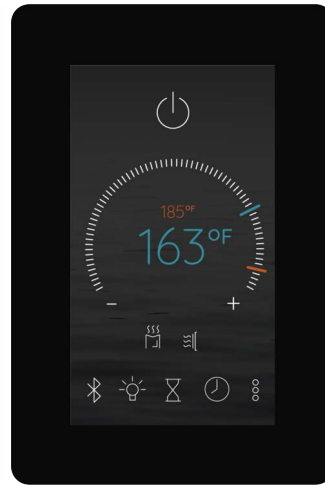

Bliss IS Control
(1601-53)



Contactor (CB) Box
CB22-1 (1201-22-1)

Figure 1.

Use these instructions when assembling the Tylö® Kiruna Hybrid™ 3 sauna room. For best results and for protection of product warranty, please read, understand and follow all safety information, safety placards, and installation and operating instructions prior to starting the installation process. When completed, leave these instructions with the owner.

If questions arise regarding this product or this manual, please contact your authorized Tylö dealership. They are trained professionals who are familiar with the product as well as new sauna ownership concerns. Their expertise will facilitate the enjoyment of your new **Tylö** sauna.

SECTION 2. SAFETY INFORMATION

2.1. CONSTRUCTION and INSTALLATION SAFETY



WARNING - ELECTRIC SHOCK HAZARD: High voltage exists within this equipment. There are no user-serviceable parts within this equipment. Have the equipment installed and serviced only by qualified and licensed personnel in accordance with local and national codes.



WARNING - ELECTRIC SHOCK HAZARD: DO NOT install electrical receptacles inside the sauna room.



WARNING: If installing a fire sprinkler system inside the sauna room, ensure it is properly rated for sauna room temperatures.



CAUTION: During construction, observe all recommended minimum safe distances between the heater and combustible materials. See the MINIMUM DISTANCE to COMBUSTIBLE MATERIALS diagram of the associated heater **Installation and Operating Instructions**. Recheck all measurements to verify minimum safe distances are maintained.



CAUTION: DO NOT construct the sauna room as to restrict air flow through the bottom of the heater. Ensure proper ventilation locations and air exchange rates are provided for volume of sauna room. See the SAUNA ROOM VENTILATION section of the associated heater **Installation and Operating Instructions**.



CAUTION: Loose electrical connections can cause heat damage to wires, terminal blocks and other components. Improper connections may void product warranty. Ensure all electrical connections are installed and inspected by qualified and licensed personnel.



IMPORTANT: The door to the sauna room must open outward, to the exterior of the sauna room.



IMPORTANT: DO NOT install a lock or mechanical locking device onto the door of the sauna room. If needed, use only a magnetic or spring-loaded catch mechanism that allows the door to open when pressed or pulled.



IMPORTANT: To prevent electrical shock, provide adequate electrical grounding to the heater and CB Box.



IMPORTANT: Do not install a shower in the sauna room.

NOTE: Use only approved sauna room materials for interior construction of the sauna room. Installation of unapproved materials or accessories may void product warranty

NOTE: To protect product warranty, only qualified licensed personnel should perform installation and service to this equipment.

NOTE: A GFCI (Ground-Fault Circuit Interrupter) device is not required by NEC. Only install a GFCI if required by local codes, however, be aware this will cause nuisance electrical circuit trips during use of the product.

2.2. USER and OPERATIONAL SAFETY



WARNING: Prolonged exposure to elevated temperatures can induce hyperthermia. Hyperthermia occurs when internal body temperature reaches several degrees above normal (98.6°F). Symptoms of hyperthermia include an increase in body temperature, dizziness, lethargy, drowsiness, and fainting. Effects of hyperthermia include failure to perceive heat, failure to recognize the need to exit the room, unawareness of impending hazard, fetal damage in pregnant women, physical inability to exit the room and unconsciousness.



WARNING: DO NOT take a sauna if using alcohol, recreational drugs, or prescribed medication as these may greatly increase risk of hyperthermia, personal injury or death.



WARNING - FIRE HAZARD: DO NOT use the sauna room for drying clothes, bathing suits, towels, etc. **DO NOT** hang towels above heater or place objects onto the sauna heater. Only place rocks supplied with the heater onto the heating elements. **DO NOT** place combustible materials onto the sauna heater.



WARNING - FIRE HAZARD: IMMEDIATELY DISCONTINUE using the sauna if the walls or ceiling exhibit unusual discoloration and/or darken in color.



WARNING - HOT SURFACES: The heater is extremely hot during operation. Keep hair, head, hands, body, and appendages on the safe side of guard rails. Keep children and vulnerable individuals a safe distance away from the heater. **DO NOT TOUCH** the heater while in operation as severe burns to skin may result.



WARNING - CORROSIVE: DO NOT pour chlorinated pool or spa water onto the heater as corrosion will occur and void product warranty.



WARNING: DO NOT pour excessive water onto the heater as damage may occur and void product warranty.



IMPORTANT: If pregnant or a person in poor health, consult with a physician before using sauna.



IMPORTANT: DO NOT exercise, play or roughhouse while using the sauna. Be safe and respectful of everyone.



IMPORTANT: Keep children, minors, and vulnerable individuals a safe distance away from a warming or hot sauna heater. Be a responsible sauna user. When needed, provide operating instructions to those less experienced. Keep operation of the sauna safe for yourself and others to enjoy.



IMPORTANT: Do not spray water on infrared emitters. Use of water on infrared emitters may cause damage and will void the warranty.

NOTE: Inspect the sauna regularly. Check for maintenance of the heater, control, and benches. Replace wood surfaces should any show signs of deterioration.

SECTION 3. INSTALLATION REQUIREMENTS

To ensure safe use of the IS sauna room, verify the following criteria are met:

- At least three (3) adults are required for the assembly and installation of the room.
- Ensure all electrical wiring is installed in accordance with NEC, state, and local codes.
- The hybrid sauna room is designed to operate on 240 Volts AC single phase power.
- The Sense UB (1802-60-1902) requires 25 amp service. Install electrical wire that is rated appropriately to meet or exceed the *Maximum Current Load* from the electrical panel to the contactor (CB) box of the sauna room.

Heater Model	KW	Maximum Current Load	Minimum Wire Rating From Power Supply to CB Box	Minimum Wire Rating From CB Box to Heater
Sense UB 6	6.0	25 Amp	#2 10AWG +Gr	#2 10AWG +Gr

- A 240 VAC dedicated circuit is recommended to avoid unnecessary tripping of the assigned circuit breaker.
- Ensure the circuit breaker is rated to *ONLY* meet the design limit of the *Maximum Current Load*. Do not install an oversized/over-rated circuit breaker. Do not exceed the safety rating of the *Maximum Current Load*.
- Provide adequate grounding from the electrical supply panel to the CB box.
- When installation is complete, ensure the sauna room air inlet and exhaust vents are open and free from blockage and obstructions.

SECTION 4. PART LIST and TOOL REQUIREMENTS

PART LIST

Before starting the assembly process inspect packaging and verify contents.

Each box label indicates the model of the sauna room and serial number. Each label also provides a brief description of contents.

The hardware package with each room includes a T20 Torx bit.

- **Box #1:** Floor and ceiling
- **Box #2:** Left and right walls, door and right window glass
- **Box #3:** Left and right back walls, left window glass.
- **Box #4:** Upper, lower and return benches, door handle, hardware kit, CB box, manuals

6000-012

RM Tylo Kiruna Hybrid 3 W/BLISS
240V LOW EMR CB22-1 V1
SL# CSF30ABIS565TL-V1-4964



6000-012

RM Tylo Kiruna Hybrid 3 W/BLISS
240V LOW EMR CB22-1 V1
SL# CSF30ABIS565TL-V1-4964



6000-012

RM Tylo Kiruna Hybrid 3 W/BLISS
240V LOW EMR CB22-1 V1
SL# CSF30ABIS565TL-V1-4964



6000-012

RM Tylo Kiruna Hybrid 3 W/BLISS
240V LOW EMR CB22-1 V1
SL# CSF30ABIS565TL-V1-4964

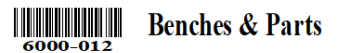

Should it be necessary to contact your dealer or technical support, record the model and serial numbers from each box.

Box Number _____

Serial Number _____

Model Number _____

Box Number _____

Serial Number _____

Model Number _____

Box Number _____

Serial Number _____

Model Number _____

Box Number _____

Serial Number _____

Model Number _____

TOOL REQUIREMENTS

- Box knife
- #2 Phillips Head Screw Driver
- T20 Torx Drive
- Bubble level
- Two (2) glass lifting suction cups
- Non-marring rubber mallet
- Common glue stick
- Roll of blue painter’s tape

SECTION 5. SAUNA ROOM ASSEMBLY

Use these instructions for assembling the Hybrid 3-person sauna room.

LAYING THE FLOOR PANEL

1. Place the floor panel on a flat, level surface, between 3 and 6 inches away from nearby walls.

Each edge of the base is labeled with numbers to correspond with the panels as they are installed. The edge labeled #5 is the FRONT of the sauna room.

2. Orient edge #5 to where you want the front of the sauna to be.
3. Fish out the end of the lighting cable from the front left corner of the bottom trim. Watch after the cable to keep it safe.
4. Using a bubble level, check the floor panel for level. If necessary, use wooden shims beneath the floor panel to make level.

INSTALLING BACK RIGHT WALL SECTION

The back wall is in two (2) sections (Labeled #1 and #2).

5. Pull the cable bundles away from the edge of the wall.
6. Place the hangers of the back *Right* wall section into the mating hangers located on the back edge of the floor panel labeled #1.
7. Hold the back *Right* wall in place until the back *Left* wall section is installed.



Figure 2. Laying the Floor Panel



Figure 3. Installing Back Right Wall Section

INSTALLING BACK LEFT WALL SECTION

8. Place the hangers of the back *Left* wall section into the mating hangers located on the back *Left* edge of the floor panel labeled #2.
9. Lift up the *Left* wall section and slide the edge brackets into the mating brackets located on the edge of the back *Right* wall section.
10. Hold the back wall assembly in place until the left wall section is installed.



Figure 4. Installing Back Left Wall Section

INSTALLING LEFT WALL SECTION

11. Place the hangers of the left wall section into the mating hangers located on the left edge of the floor panel labeled #3.
12. Lift up the left wall and slide the edge brackets into the mating brackets located on the back wall.



Figure 5. Installing Left Wall Section

INSTALLING RIGHT WALL SECTION

13. Place the hangers of the right wall section into the mating hangers located on the right edge of the floor panel labeled #4.
14. Lift up the right wall and slide the edge brackets into the mating brackets located on the back wall.
15. When the wall panels are mated correctly, verify the top edges where the corners meet are flat and flush.

INSTALLING CONTACTOR (CB) BOX

16. Remove the cover of the CB Box to gain access to the four (4) mounting holes located in the back of the box.
17. Set the hardware and cover aside in a safe location.
18. Position the CB Box onto the wooden “L” trim located inside of the right wall.
19. Using the four (4) 3/16” x 3/4” screws supplied with the kit, attach the CB Box to the wall.
20. Use the following sub-steps if the cable track is not already pre-installed.
 - a. Remove the adhesive backing from the double-sided tape adhered on the back of the cable track.
 - b. Apply the cable track along the corner of the wall beneath the CB box.

CONNECTING IR Emitters

Electrical installation must be made by a licensed electrician in accordance with the National Electric Code and local regulations.

NOTE: The right wall is omitted in Figure 8. for clarity.

21. Connect the left wall IR power cable to the connector on the left wall PCA board.
22. Connect the left, back wall IR power cable to the connector on the left back wall PCA board.
23. Using the screws provided, attach the junction box covers.
24. Route the power cable into the J channel.
25. Connect the right wall IR power cable to the connector on the right wall PCA board.
26. Using the screws provided, attach the junction box cover.

NOTE: Installation of the bench skirt IR power cable is described in “INSTALLING BENCH SKIRT” on page 11.



Figure 6. Installing Right Wall Section



Figure 7. Mounting the CB Box to the Wall

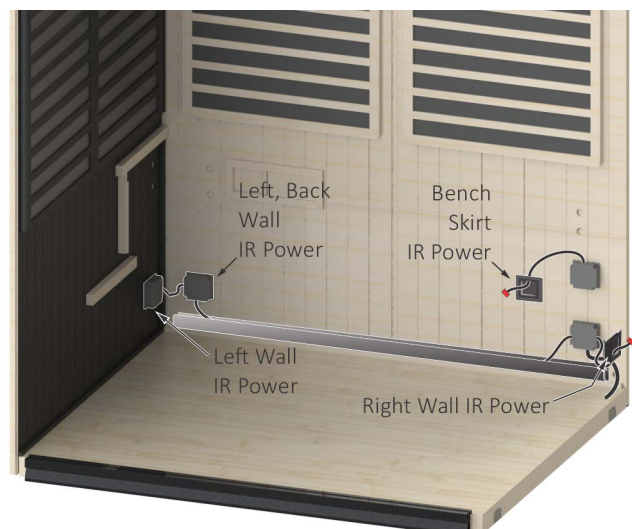

Figure 8. Connecting IR Emitters

CONNECTING CABLES

27. From the cable chases, route the low voltage cables through a bottom opening located on the low voltage side of the CB box.
28. Route the power cables through bottom openings located on the high voltage side of the CB box.
29. The sauna room wires and cables are labeled according to the terminals they connect to inside the CB box. See Figure 9.
30. For additional electrical information, see “SECTION 6. ELECTRICAL HOOK-UP” on page 19.

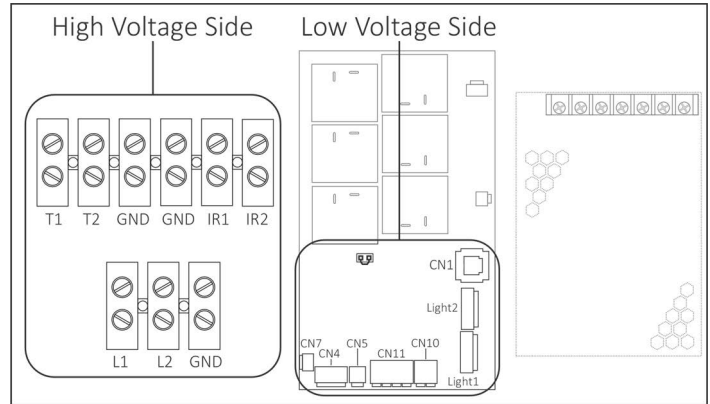

Figure 9. CB Box Interior

INSTALLING FRONT EDGE TRIM

31. Bring the bottom of the left front edge trim near the base on the left.
32. Connect the light cable from the bottom trim to the corresponding cable on the left front edge trim.
33. Carefully feed to excess cable into the chase provided in the edge of the bottom trim.
34. Keep the cable and connector from being pinched during assembly of the edge trim.
35. Install the left front edge trim to the edge of the left wall.

TIP: * Leave the right front edge trim uninstalled until after the benches are installed.
36. *Install the right front edge trim to the front edge of the right wall.

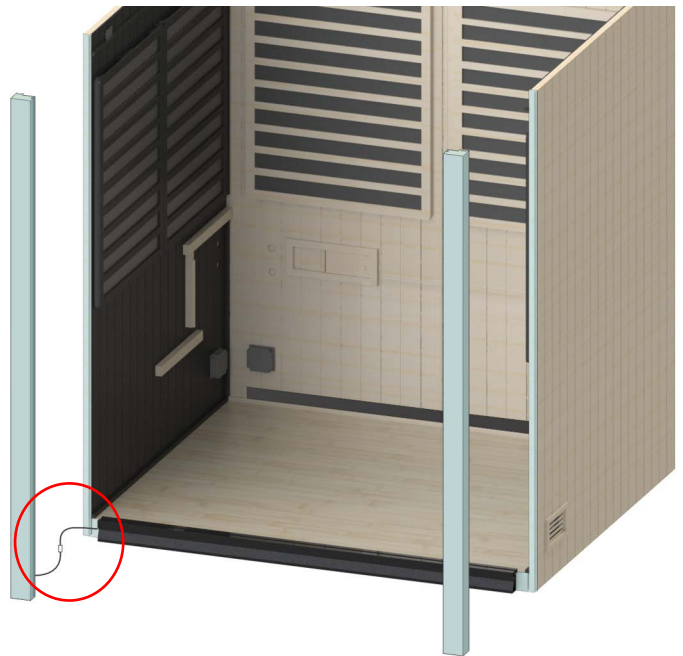

Figure 10. Installing Front Edge Trim

INSTALLING LOWER BENCH SEAT

Use Figure 11. for the steps below.

37. Slide the lower bench seat over the top of the left and right lower bench braces.
38. Connect the bench lighting cable to the corresponding cable from the right wall.



Figure 11. Installing Lower Bench

INSTALLING BENCH SKIRT

Use Figure 12. for the steps below.

39. Orient the bench skirt so the “tongue” on the planks are to the left, and the “groove” on the planks are to the right with the IR emitter panel facing to the front of the sauna room.
40. From above the lower bench, ease the left and right edges of the bench skirt down onto the large “tongues” attached on the left and right walls.
41. Connect the bench skirt IR power cable (see Figure 8.) to the PCA circuit board located on the back of the bench skirt.
42. Using the screws provided, attach the junction box cover to the back on the bench skirt.
43. Latch the bench skirt to the left and right walls.



Figure 12. Installing Bench Skirt

44. Install the skirt support brace.



Figure 13. Installing Skirt Support Brace

INSTALLING UPPER BENCH SEAT

Use Figure 14. for the steps below.

45. Slide the upper bench seat partially over the top of the left and right upper bench braces.
46. Connect the bench lighting cable to the corresponding cable from the right wall.
47. Slide the upper bench seat all the way to the back wall.
48. Re-install the Right front trim if it was removed.

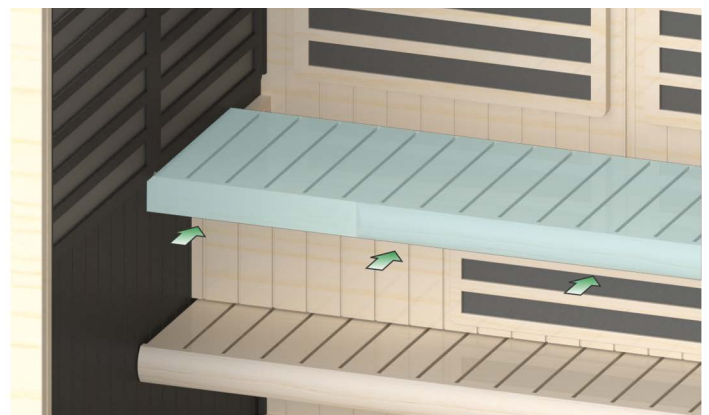

Figure 14. Installing Upper Bench Seat

INSTALLING ARMREST AND RETURN BENCH

Use Figure 15. for the following steps.

49. Bring the armrest into the room and position it in the left front corner next to where the glass will be (A).
50. Bring the return bench into the room (B). Rest the front edge onto the armrest brace and position the rear edge to the front left edge of the upper bench.
51. Using two (2) M4 x 50mm T20 Torx head screws, attach the rear edge of the return bench to the front left edge of the upper bench (C).
52. Using two (2) M4 x 50mm T20 Torx head screws, attach the armrest frame to the trim (D).
53. Using two (2) M4 x 50mm T20 Torx head screws, attach the front edge of the return bench to the armrest brace (E).
54. Neaten up all of the cables and tuck into the wall and secure hanging cables with cable ties beneath the benches.

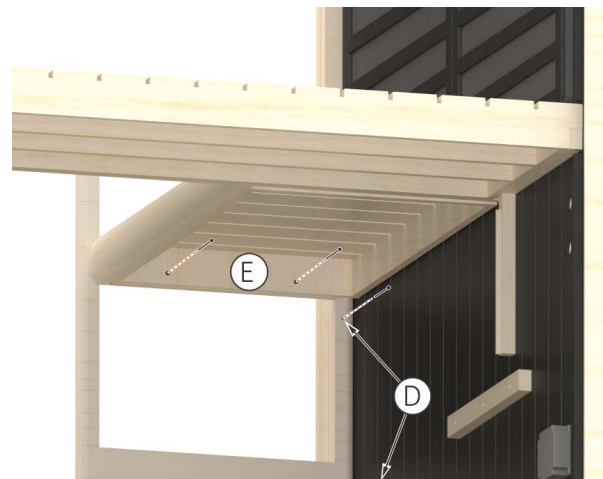
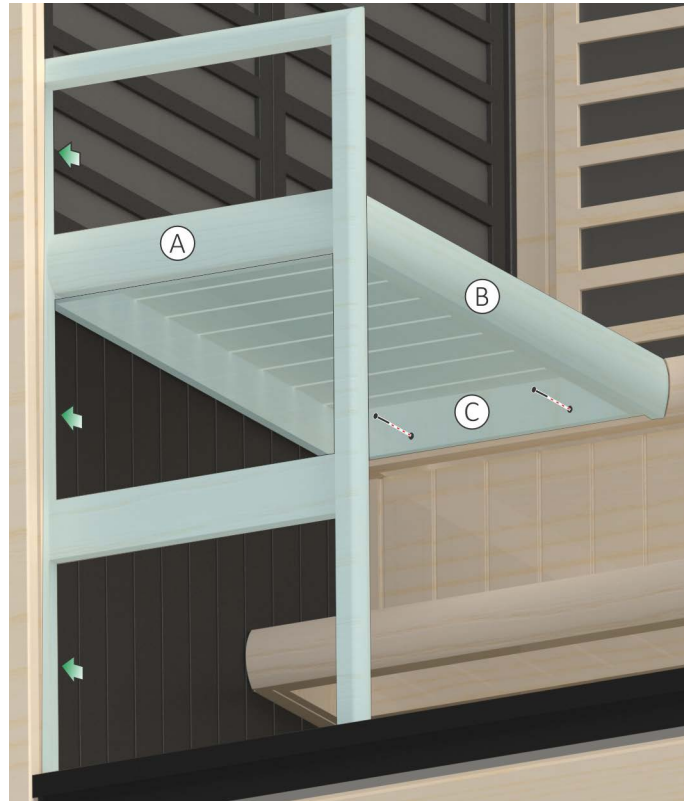

Figure 15. Installing Armrest and Return Bench

INSTALLING THE SINGLE GLASS PANE

NOTE: Use glass lifting suction cups when lifting and aligning glass panes.

55. Orient the single glass pane on the right side of the room with the attached door seal mating surface facing outward.

NOTE: To help orientation, the words “Tempered Glass” are etched along the bottom edge of all glass panels.

The U-gasket material goes along the top and bottom edges of glass pane, then into the U-channels of the footer and ceiling.

TIP: *Using a glue stick, apply a thin layer of adhesive along the bottom inside and outside edges of glass. Then follow the instruction in the step below while adhering the bottom U-gasket in place.

56. *Align door edge of U-gasket flush to the edge of the glass.

57. Carefully lift and place the bottom edge of the glass pane into the U-channel of the footer.

58. Align edge of the glass pane with the U-channel cut into the edge of wall panel and carefully press into place.

59. Re-verify the orientation of the door seal mating surface is facing outward.

TIP: **Using blue painter’s tape, temporarily secure the top portion of the glass pane to the right corner trim.

60. **Hold the glass pane in place while preparing for installation of the door assembly.

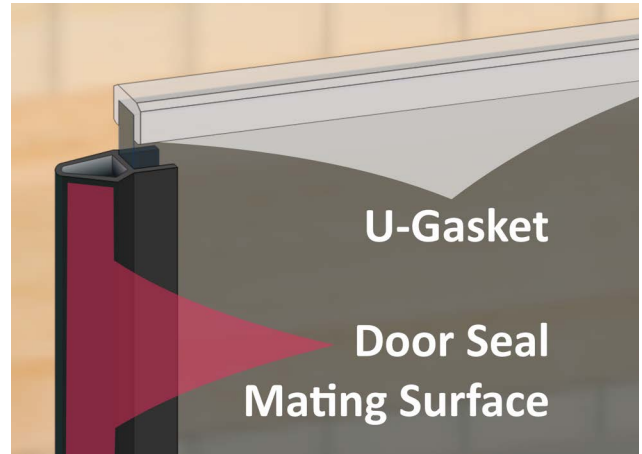

Figure 16. Single Glass Pane Orientation & U-Gasket



Figure 17. Installing the Single Glass Pane



HEAVY OBJECT: The door assembly is extremely heavy and fragile. It is best practice to have three (3) people assist during installation.

DOOR SEAL ORIENTATION

61. Orient the door assembly so that the attached door seal will mate correctly with the door seal on the single pane.

The single pane door seal faces outward, away from the sauna room, while the seal on the edge of the door faces inward towards the room.

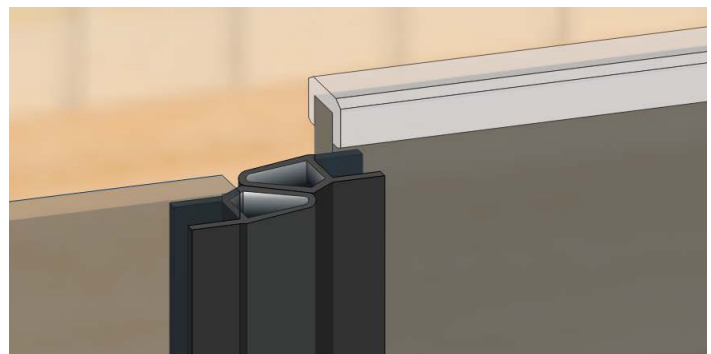

Figure 18. Door Seal Orientation

INSTALLING DOOR HANDLE

62. Arrange the door handles and hardware as shown in Figure 19. Screws and cap are installed from inside the door.
63. Place the door handles on either side of the glass door, aligning with the holes in the glass.
64. Install the spacers into the holes in the glass.
65. Using the two (2) M4 x 100mm Phillips head screws included in the kit, attach the door handles to the glass door.
NOTE: Install screws by hand with a screw driver
DO NOT USE a power tool.
66. Install the caps into the ends of the handle screw holes.

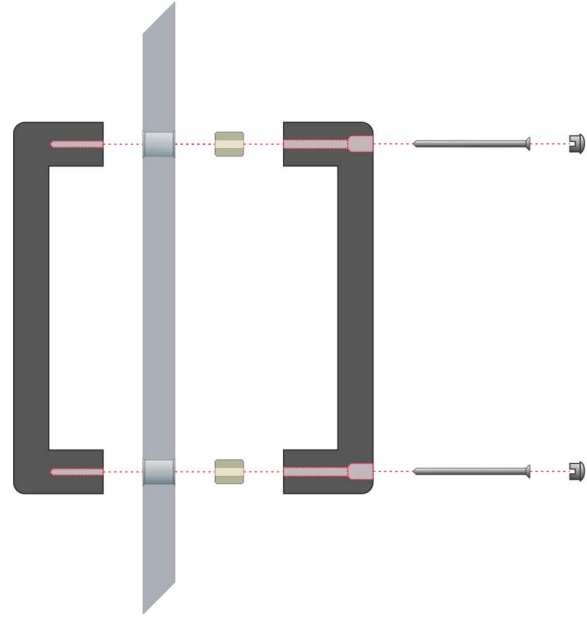

Figure 19. Installing Door Handle

INSTALLING THE DOOR ASSEMBLY

The U-gasket material goes along the top and bottom edges of glass pane, then into the U-channels of the footer and ceiling.

TIP: *Using a glue stick, apply a thin layer of adhesive along the bottom inside and outside edges of glass. Then follow the instruction in the step below while adhering the bottom U-gasket in place.

67. *Align door edge of U-gasket flush to the edge of the glass.
TIP: **Angle the door assembly such that the lower right corner of the glass pane enters the footer U-channel first.
68. **Carefully lift and place the bottom edge of the glass pane into the U-channel of the footer.
69. Align edge of the glass pane with the channel cut into the edge of wall panel and carefully press into place.
70. Re-verify the orientation of the attached door seal correctly mates with the single pane seal.



Figure 20. Installing the Door Assembly

PREPARING THE CEILING

NOTE: The ceiling is heavy and handling is awkward. It is best to stand inside the sauna room while guiding the ceiling into position.

71. From the top of the left, right, and back wall sections, Pull the ends of the cables out and away, over the outside edges.
72. Place two (2) foam blocks on top of the front left and right corners.
73. Slowly lower the ceiling into place, starting from the back of the room first, then onto the foam blocks at the front.

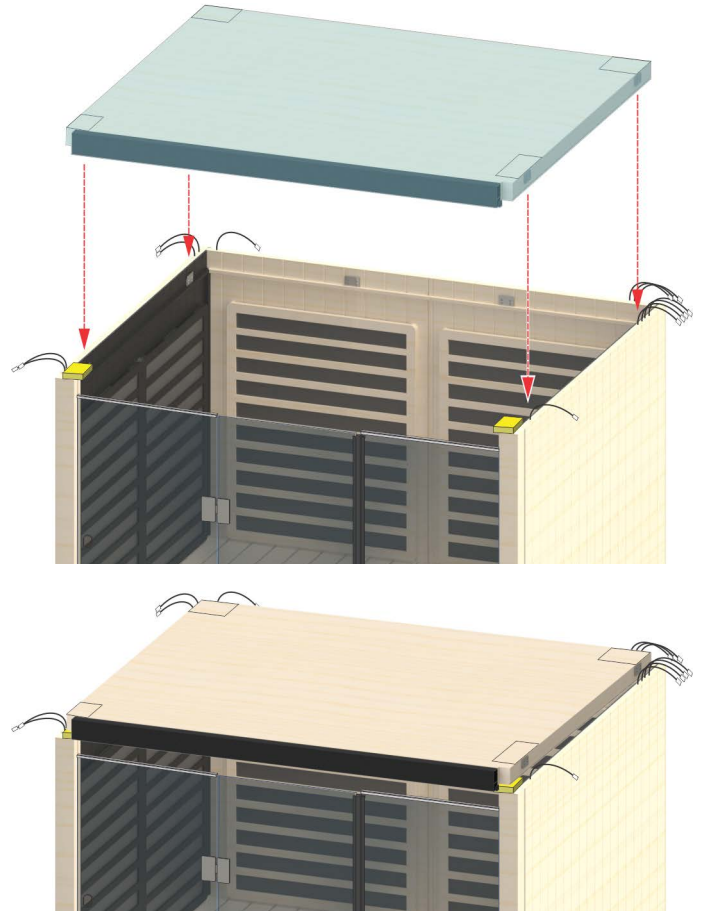

Figure 21. Preparing the Ceiling

INSTALLING THE CEILING

74. Ensure the cables located along the top edges of the walls are clear of the pinch points.
75. Remove the two (2) foam blocks.
76. Carefully guide edges of the two (2) glass panes into the channel on the metal edge of the ceiling.
77. Guide the ceiling down onto the mating brackets on the left, right, and back wall sections.

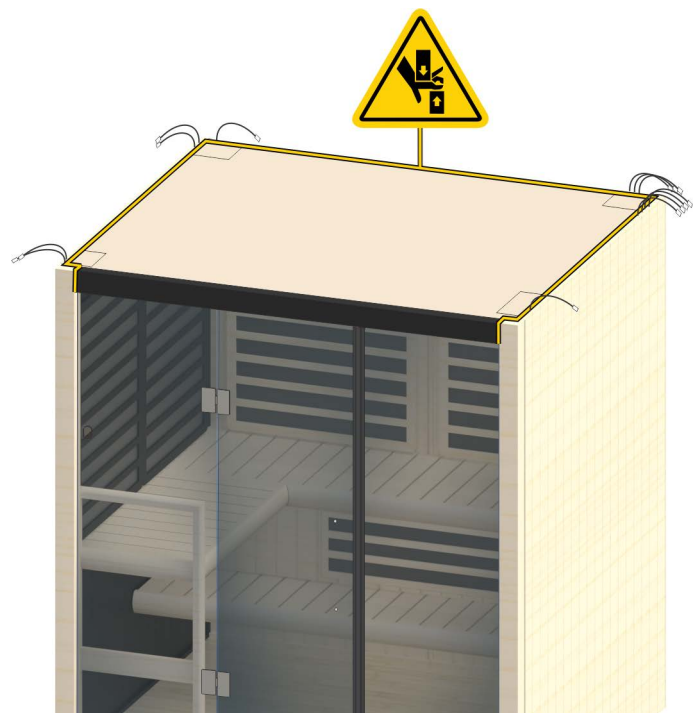

Figure 22. Installing the Ceiling

INSTALLING CORNER STIFFENING BRACKETS

NOTE: The brackets provided with this kit may have a different appearance than what is shown in Figure 23.

78. If pilot holes were not provided on the top corners, it may be necessary to pre-drill holes for installation of the bracket screws.
- Press the corner trim tight into the corner and use the brackets as a hole placement guide.
79. Using the screws provided, Install the corner stiffening brackets included with this kit.

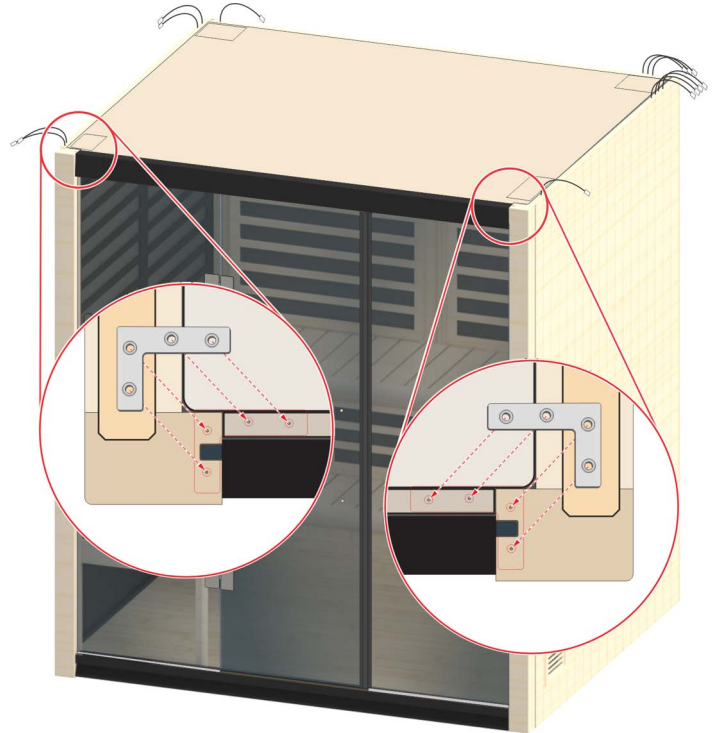

Figure 23. Installing Corner Stiffening Brackets

80. From the top of the ceiling, open the four (4) hatches located on the front left, right, and back left and right.

ELECTRICAL CONNECTIONS - Ceiling, Back Right Corner

- 81. Fish out the eight (8) cables from the hatch.
- 82. Connect back wall CN1 cable to the CN1 ceiling cable.
- 83. Connect the back wall CN7 cable to the CN7 ceiling cable.
- 84. Connect the two (2) back wall #7 cables to the two (2) #7 ceiling cables.
- 85. Connect right wall CN4 cable to the CN4 ceiling cable.
- 86. Connect the two (2) right wall #6 cables to the two (2) #6 ceiling cables.
- 87. Connect right wall #7 cable to the #7 ceiling cable.
- 88. Dress the wall cables into the trenches and close the hatch.

ELECTRICAL CONNECTIONS - Ceiling, Front Right Corner

- 89. Fish out the two (2) cables from the hatch.
- 90. Connect right wall CN4 cable to the CN4 ceiling cable.
- 91. Connect the right wall #7 cable to the #7 ceiling cable.
- 92. Dress the wall cable into the trench and close the hatch.

ELECTRICAL CONNECTIONS - Ceiling, Front Left Corner

- 93. Fish out the three (3) cables from the hatch.
- 94. Connect front left corner #6 cable to #6 ceiling cable.
- 95. Connect front left corner CN1 cable connector to the CN1 ceiling cable.
- 96. Connect the left wall #7 cable to the #7 ceiling cable.
- 97. Dress the corner cables into the trenches and close the hatch.

ELECTRICAL CONNECTIONS - Ceiling, Back Left Corner

- 98. Fish out the two (2) cables from the hatch.
- 99. Connect back wall #7 cable to a #7 ceiling cable.
- 100. Connect left wall #7 cable to a #7 ceiling cable.
- 101. Dress the wall cables into the trenches and close the hatch

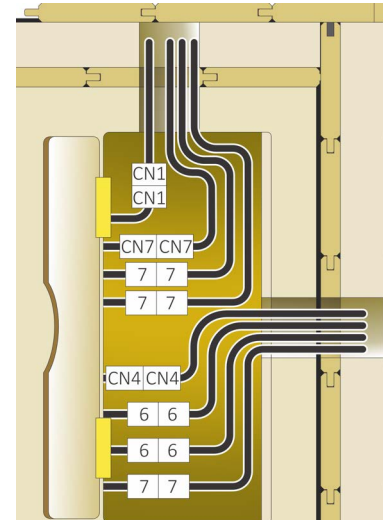

Figure 24. Ceiling, Back Right Corner

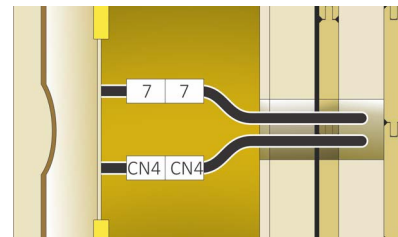

Figure 25. Ceiling, Front Right Corner

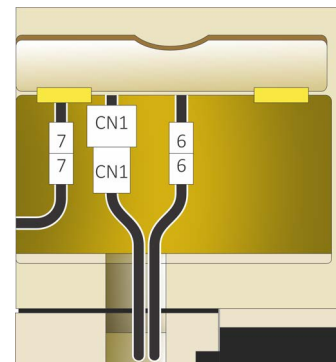

Figure 26. Ceiling, Front Left Corner

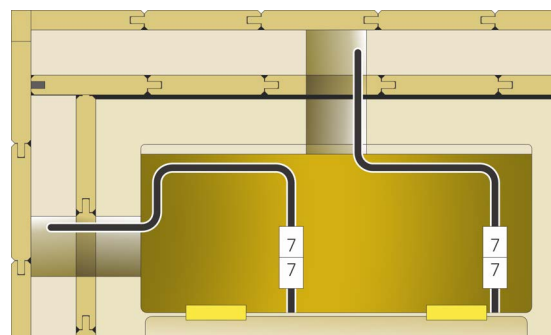

Figure 27. Ceiling, Back Left Corner

MOUNTING THE HEATER

102. Prepare the heater for installation. See the appropriate sauna heater installation and operating instruction manual.
103. Using the measurements provided in Figure 28, verify the position of the pre-drilled mounting holes for the heater.
104. Install the four (4) lag bolts (included with the heater) into the wall for mounting the heater.
105. Leave about 1/4" of the screw shaft exposed for the heater hangers to rest on.
106. Hang the heater onto the four (4) bolts, then tighten the bolts to the wall.

Instructions for electrically connecting the heater are provided later in "SECTION 6. ELECTRICAL HOOK-UP" on page 19.

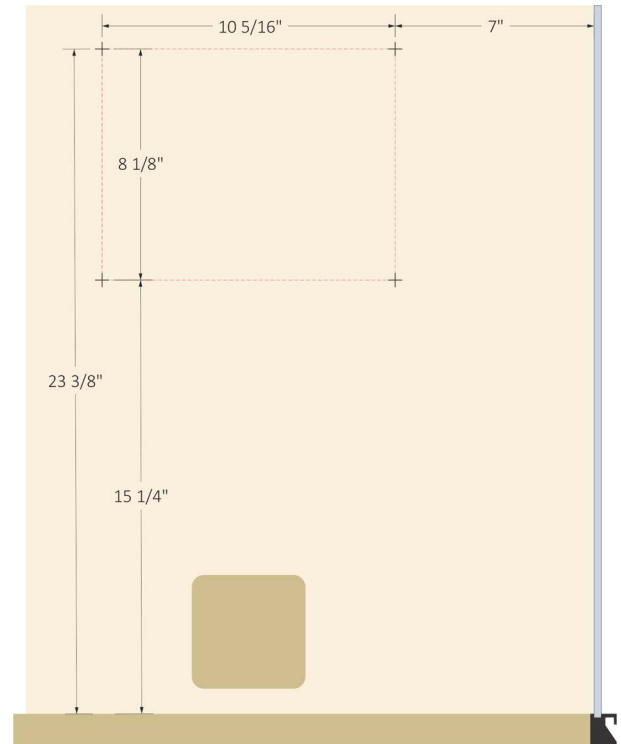

Figure 28. Heater Mounting Measurements

SECTION 6. ELECTRICAL HOOK-UP

Use Figure 29. for the following steps.

Electrical installation must be made by a licensed Electrician in accordance with the National Electric Code and local regulations.

1. Route the heater power cable through an opening located on the bottom of the CB box, high voltage side.
2. Connect wires to the correct terminals. See “DIAGRAM 1. ELECTRICAL, 240VAC 1 PHASE”.

NOTE: The heater includes a small wire harness for the high limit control. This **MUST BE CONNECTED** for safe operation of the sauna.

3. Route the high limit control wires from the sauna heater through an available hole in the bottom of the CB Box, low voltage side.

NOTE: Maintain separation of high and low voltage wires.

4. Connect the wires to the high limit terminals (CN5) on the circuit board. See “DIAGRAM 1. ELECTRICAL, 240VAC 1 PHASE”.

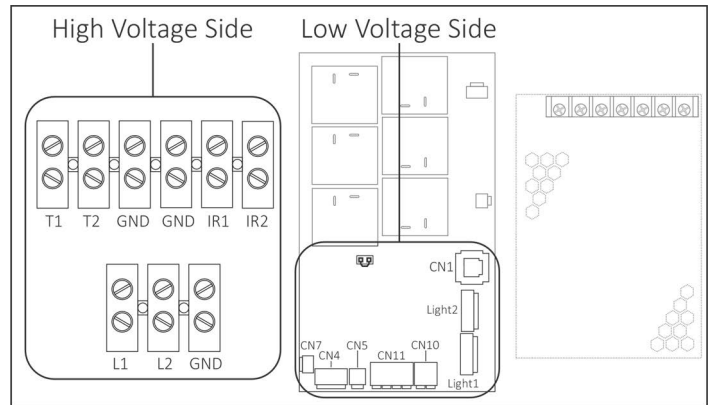

Figure 29. CB Box Interior

DIAGRAM 1. ELECTRICAL, 240VAC 1 PHASE

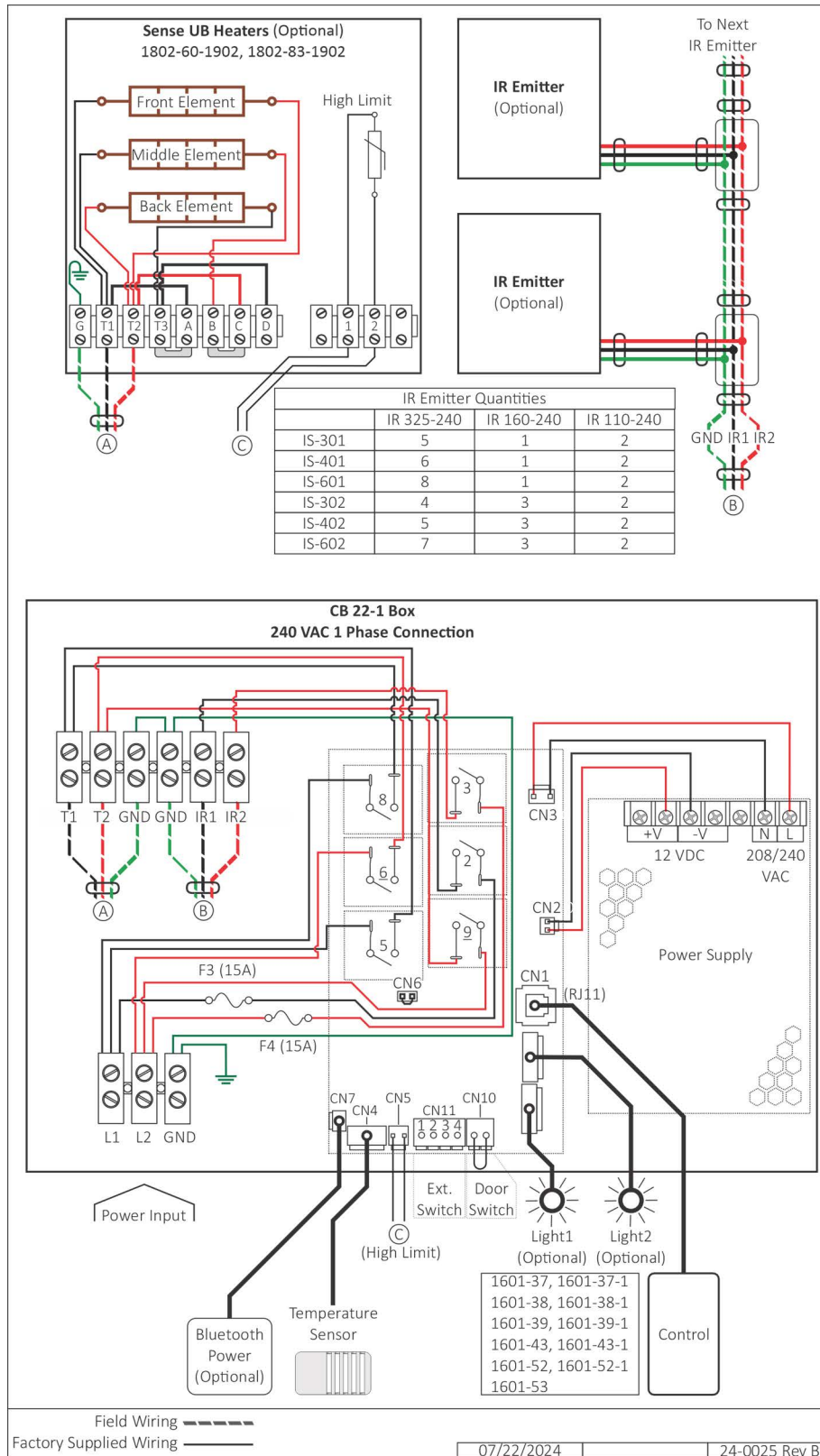
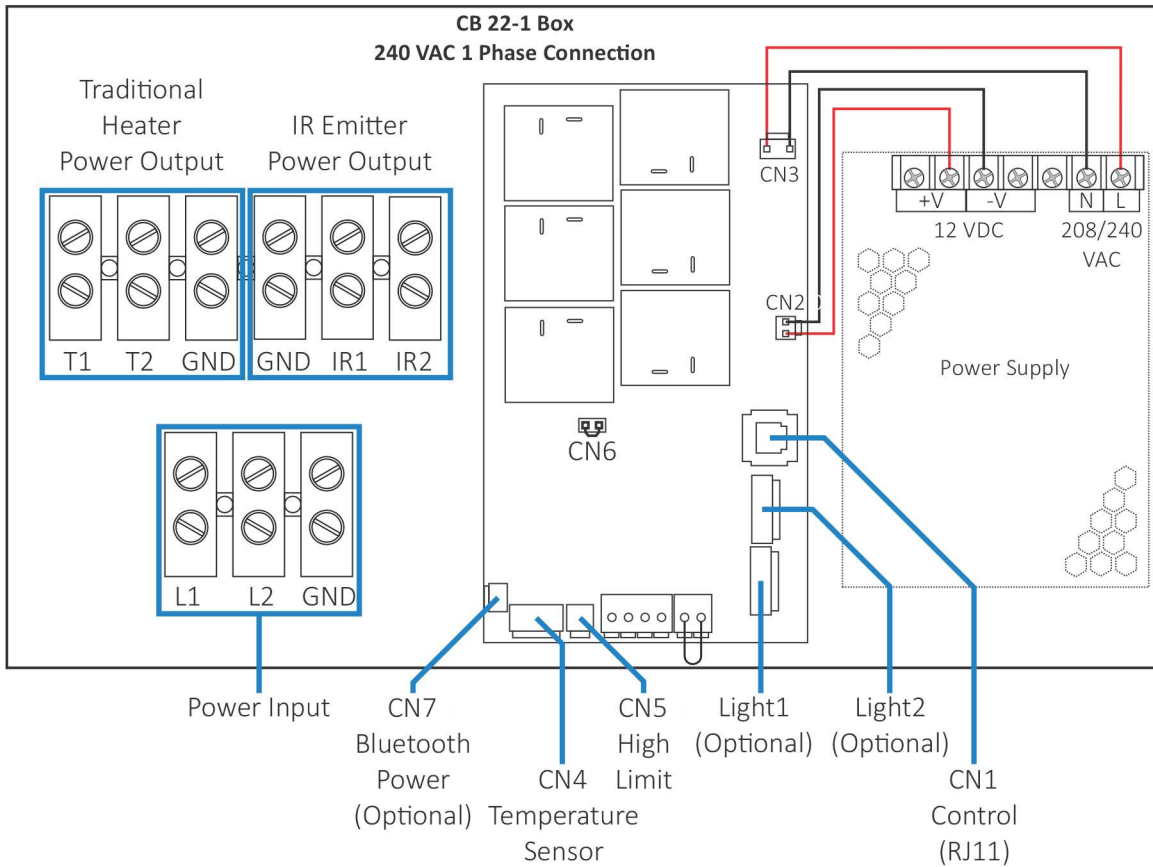

DIAGRAM 2. CB BOX INTERNAL VIEW



SECTION 7. CONTROL INSTALLATION

The Bliss IS control is weather resistant and water resistant, allowing it to mount either on the interior or exterior of the sauna room.

If the control is not already pre-installed, use the following steps to install the control.

1. Locate the keyed circular hole in the front glass for mounting the control. The control will mount on the exterior of the glass. See Figure 30. for the remaining steps.
2. Orient the UP arrow on the back of the control (A) and insert the threaded tube through the keyed circular hole in the glass.
3. Attach the control to the glass from the interior using the threaded retaining ring (B).
4. Connect the RJ11 control cable (C) to the female RJ11 jack located inside the threaded tube of the control.
5. Neaten up the control cable, then attach the back cover (D) over the threaded retaining ring (B).

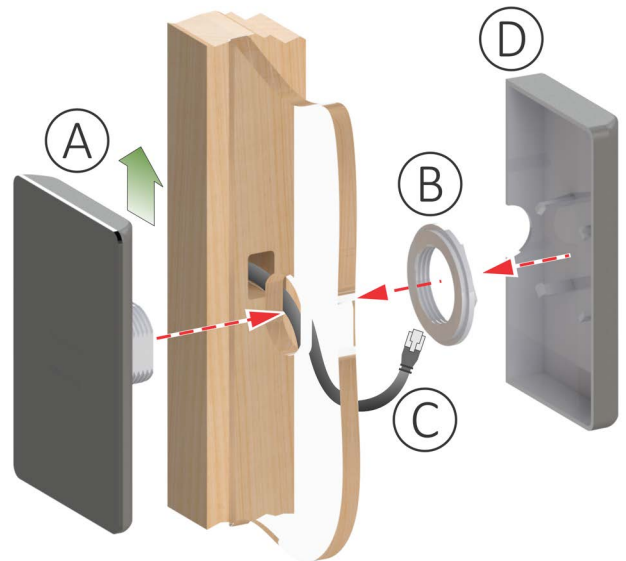

Figure 30. Installing the Control

SECTION 8. CONTROL QUICK GUIDE

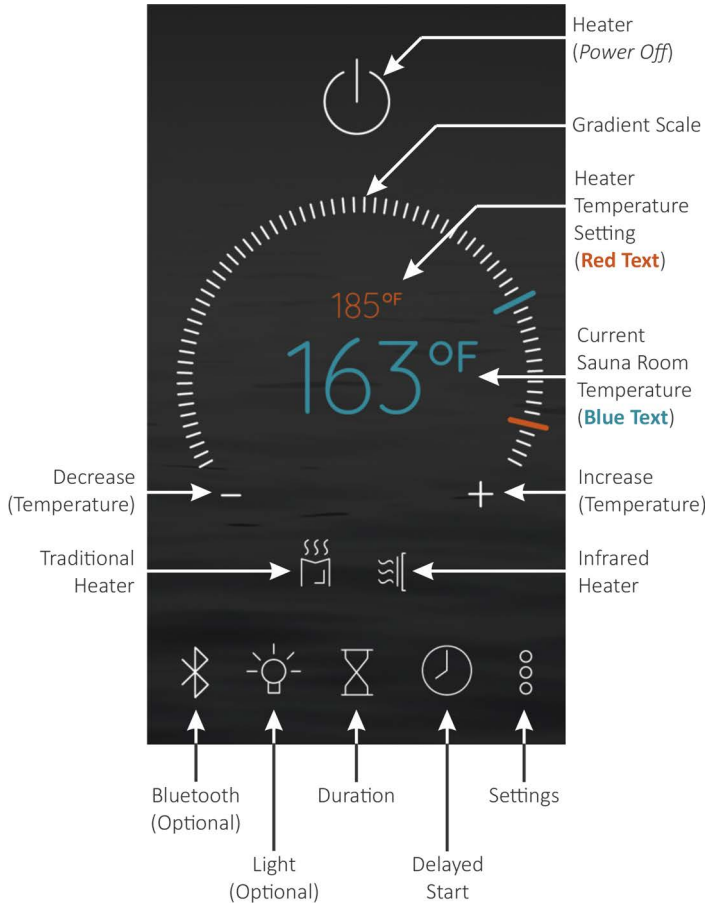

Figure 31. Control Icons

HEATER SELECTION

Tap either the **Traditional Heater** or the **Infrared Heater** icon to turn on either the traditional sauna heater or the IR emitters. For operational safety, only one or the other can be powered up at any given time.

TRADITIONAL

Tap the **Power** icon once. The default settings for the temperature is 194°F, the bath time is 60 minutes. These settings are adjustable from 119° to 194°. Length of the sauna can be set from 0 to 60 minutes. The time delay before start can be up to 24 hours. Any changes are remembered by the heater for your next bath. Should the heater power be lost then restored, the settings will return to their default values.

INFRARED

Tap the **Power** icon once. The default settings for the temperature is 149°F, the bath time is 60 minutes. These settings are adjustable from 84° to 149°. Length of the sauna can be set from 0 to 60 minutes. The time delay before start can be up to 24 hours. Any changes are remembered by the heater for your next bath. Should the heater power be lost then restored, the settings return to default values.

GRADIENT SCALE

The scale is touch sensitive. Use the tip of your finger to scroll for increasing or decreasing a selected setting (i.e. temperature, duration, light color, light intensity, bluetooth audio volume).

HEATER TEMPERATURE SETTING

The temperature setting of the selected heater is displayed in small **red** colored text.

CURRENT SAUNA ROOM TEMPERATURE

The current sauna room temperature measured by the temperature sensor is displayed in large **blue** colored text.

INCREASE

Alternative to the gradient scale, tap the plus sign (+) icon to incrementally increase a selected setting.

DECREASE

Alternative to the gradient scale, tap the minus sign (-) icon to decrementally decrease a selected setting.

SETTINGS

Tap this icon to open the *Settings* screen.

DELAYED START

Tap this icon to open the *Delayed Start* screen.

DURATION

Tap this icon to open the *Bath Time* screen.

LIGHT (Optional)

The Bliss IS control can operate one(1) or two (2) optional lighting packages purchased with the system. Tap this icon to enable/disable the lights.

BLUETOOTH (Optional)

The Bliss IS control can operate **ONLY** an optional Bluetooth® package purchased with the system. Tap this icon to enable/disable audio.

SECTION 9. PLACING SAUNA ROCKS

The rocks supplied with the heater were selected with the best traditional sauna performance in mind.



HEAVY OBJECT: A full container of rocks is heavy. To avoid injury, bend at the knees when picking up the box.

- Use of other rock types may void heater warranty.
- **NEVER** operate heater without rocks in place!
- **RINSE** rocks with water before placing in the heater.

CAREFULLY place rocks loosely around the heater elements to allow efficient air circulation.

1. Remove the heater guard from the top of the heater.

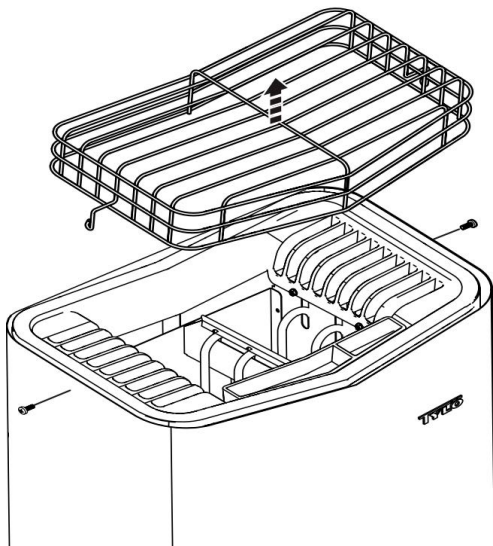

Figure 32. Removing Heater Guard

2. For the first layers, place smaller rocks around the outer perimeter of the heating elements.
3. Fill the middle sections with larger rocks.
4. Ensure the elements stay vertical while carefully filling the heater with rocks.
5. Place rocks loosely in the center of heater to allow heat to rise easily up the middle of heater.
6. Loosely cover the tops of all elements with rocks.

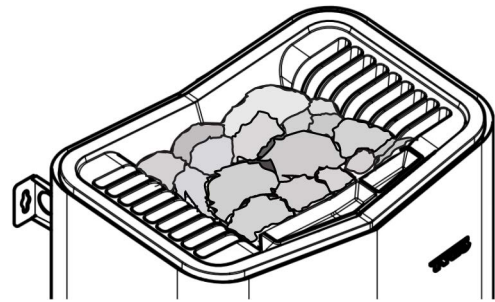

Figure 33. Placing Rocks on Top of Elements

7. Be careful not to pack the rocks too densely on top of the heater elements or onto the side chambers as this can impede airflow.

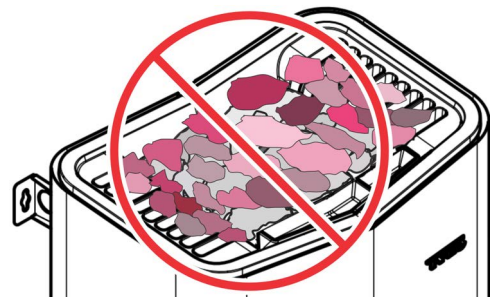

Figure 34. Do Not Pack Rocks Too Densely

8. Re-install the heater guard with the screws removed previously.

SECTION 10. HOW TO TAKE A SAUNA

- Devote adequate time to completely relax while taking a sauna bath.
- Before using the sauna, avoid eating a large meal and intake of alcoholic beverages. **DO NOT** smoke, exercise or drink alcoholic beverages while in the sauna room.
- If taking prescribed medications and/or under the care of a physician, consult with them prior to using the sauna.
- Remove clothing and jewelry. If preferred, wear loose-fitting clothes.
- For best results, take a warm shower before the sauna, then apply a towel loosely about the body. Enter the sauna wet without padding down to dry.
- Enjoy listening to audio books or music while relaxing in the sauna. Depending on preference, sit or lay down on the bench, adjust the vent to provide adequate air circulation.
- If desired, add colored light therapy to the experience.

When Partaking in a Traditional Sauna:

- Enjoy the soothing effect of steam by splashing a small amount of water onto the heated sauna rock. Use one dipper full (approximately 1/2 cup) of clean water at a time, keeping exposed skin clear of the steam as it rises off the rocks.
- **DO NOT** use chlorinated pool or spa water, as corrosion damage may result.

When Partaking in an Infrared Sauna:

- An IR sauna produces infrared wavelengths that are absorbed by skin tissue in a span of 10-15 minutes. It is not necessary to wait until the sauna has reached maximum temperature. The absorption rate is the same whether the room is warming up or at its maximum temperature.
- **DO NOT** splash water onto the IR emitters as this may cause damage and void product warranty.
- After ten (10) minutes or when perspiration begins, exit from the sauna, relax in the dressing area, followed by a cool shower.
- Stay hydrated, drinking water is best.
- The allotted cool down time should equal the amount of time occupying the sauna. The amount of time varies by the individual.
- Step back into the sauna room and remain for five (5) or ten (10) minutes.
- Repeat the cycle two (2) or three (3) more times.
- Enjoy a final shower or bath to cool down. Bask in the special sauna “after glow”. Partake in a healthy snack and/or a cool, refreshing drink.
- Put on clothing only after perspiration has stopped and the body is completely dry.

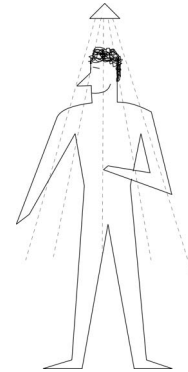

Shower



Sauna Bathe

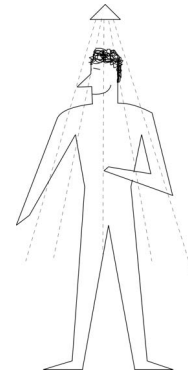

Shower

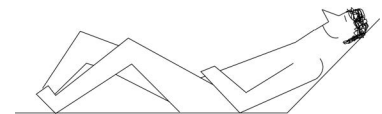

Rest/Relax



Hydrate

SECTION 11. MAINTENANCE

Inspect sauna room at the end of each day the room to ensure the control and system is off.

The sauna, like a bathroom, should be kept clean and odor free. Towels or mats should always be used on benches and floor as perspiration otherwise penetrates the soft wood. To clean and remove perspiration stains, use soap or detergent in warm water, best applied with a scrub brush. Badly soiled surfaces may require sanding. Sand paper wrapped around a wooden block works well.

Air out the sauna often by keeping the door and vents open when the sauna is not in use. Saunas that are in daily use should be washed down at least once a week to keep them clean and the air fresh. Duck board should be removed from the sauna, the sauna floor mopped and dried in a conventional manner, and the duck board thoroughly scrubbed and dried before returning to the sauna room. The sauna heater should be wiped down occasionally with a damp cloth to remove lint and dust. The rocks should be removed once a year for cleaning and small or crumbled rocks replaced.

Benches and supporting structure must be inspected annually for potential deterioration due to age, dry rot or abuse. Any boards with signs of deteriorations should be replaced immediately to avoid possible injury.

SECTION 12. TROUBLESHOOTING

Should you need to contact the dealer or outlet you purchased the product, please have the model and type numbers of the heater, CB Box and control available prior to calling.

12.1. PRE-HEAT MODE

If the air temperature inside the sauna is below 10°F (-12°C) at startup, or if the temperature sensor is not detected, the *CAUTION Pre-Heat Mode* screen appears.

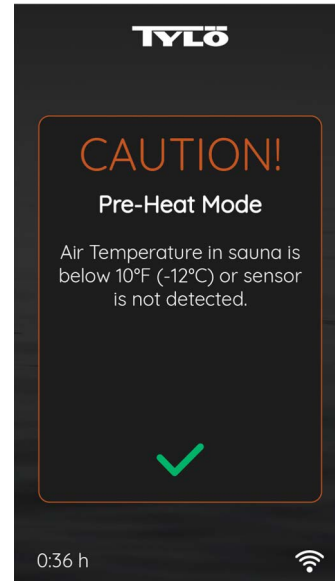

Figure 35. CAUTION Pre-Heat Mode Screen

1. Allow the heater to run for 5 minutes.
 - If the sensor is recognized, the CAUTION screen will go away.
 - If after 5 minutes the sensor is not recognized, the *WARNING Sensor Not Detected* screen appears. and the heater turns off.

12.2. SENSOR NOT DETECTED

When the sensor is not detected, power to the heater is disabled.

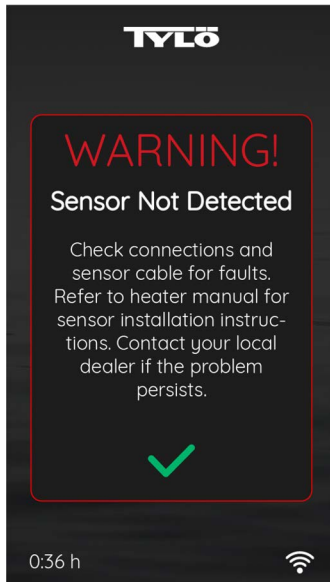

Figure 36.

1. Before performing a visual inspection, turn off circuit breakers to the sauna to remove all electrical power.
2. Refer to the content of the associated **Heater Installation and Operating Instructions** for details on the temperature sensor, cable and CB Box.
3. Check sensor electrical connections at the CB Box and at the sensor, looking for loose or broken wires, loose, corroded, or tarnished connections.
4. Inspect condition of the sensor circuit board for corrosion, tarnish and cold solder joints.
5. If the condition of the circuit board and electrical connections look good, then inspect the whole length of the sensor cable for visible damage.
6. When the inspection is completed and any user-fixable issues are corrected, re-apply power and test the operation of the sauna.
7. If the problem persists, contact your dealer.

12.3. HIGH LIMIT ERROR

When the high limit switch trips/activates, power to the heater is disabled.

While the heater is on and if the temperature at the heater rises above the high limit threshold, the heater shuts off, an audible control alarm is sounded, and the *WARNING High Limit Error* screen appears.

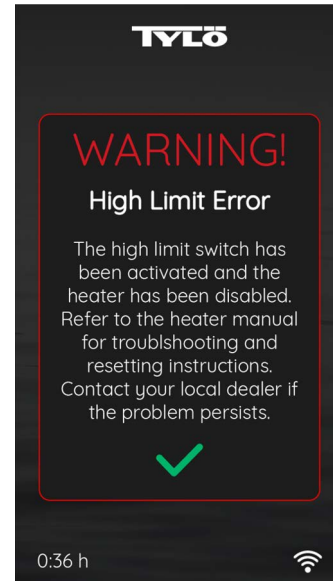

Figure 37.

1. Tap the green colored check mark.
 - The audible alarm turns off and the Home screen with heater off appears.
 - All icons on the Home screen remain functional, except for the **Power** icon.
2. Wait until temperature drops below the low temperature threshold and the high limit resets.
 - If the **Power** icon is tapped before the high limit has had time to reset, the WARNING High Limit Error screen will re-appear.
3. After the high limit has reset, tap the **Power** icon to turn the heater back on.
4. Refer to the content of the associated **Heater Installation and Operating Instructions** for details on sauna ventilation, how the heater is mounted, and placing sauna rocks to diagnose and correct the trouble. If the problem persists, contact your dealer.

12.4. DOOR OPEN

If an optional door switch (not provided by Sauna360) is installed, this message occurs when the control detects the sauna door is open for longer than 30 seconds.

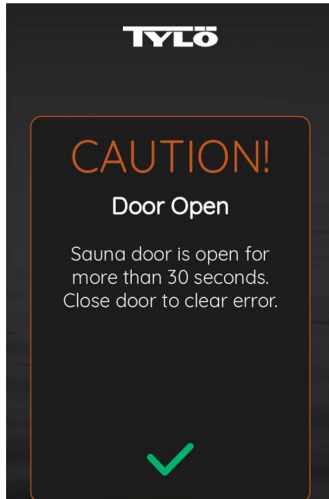

Figure 38. CAUTION Door Open

Close the door within two (2) minutes and the current sauna session will continue and the error message will go away.

If the door is open for greater than two (2) minutes, the *WARNING Door Open* screen appears and power to the heater is disabled.

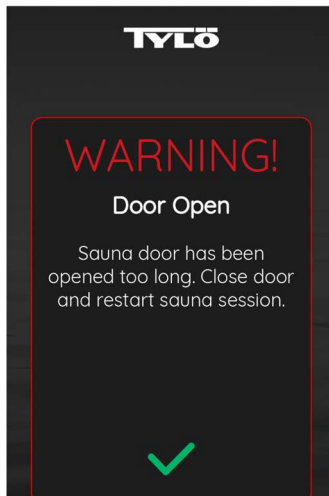

Figure 39. WARNING Door Open

Close the sauna door and press the green check mark, the Home Screen screen appears.

Press the **Power** icon to restart the sauna session.

12.5. JUMPER ERROR

This error occurs when the control detects an electrical jumper is open on the main board located in the CB Box.

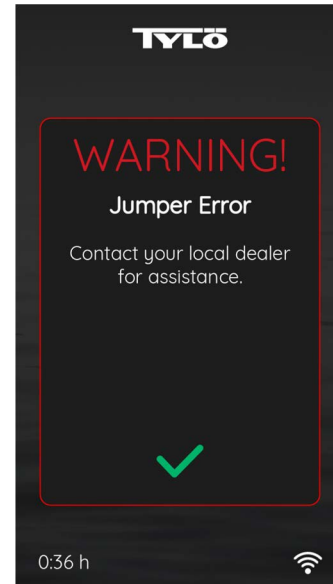

Figure 40.

There are no user-serviceable parts inside the CB Box. Shut off the breakers to the sauna and contact your dealer for assistance.

12.6. INFORMATION

When this message appears, tap the green check mark. Before inspecting, turn off the heater and allow the rocks to cool down before inspection/replacement.

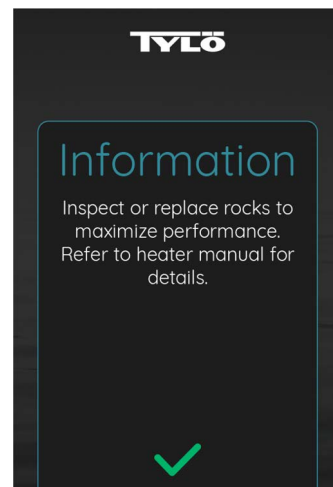

Figure 41.

©2024 Sauna360 Inc.

The Bluetooth® word mark and logos are registered trademarks owned by Bluetooth SIG, Inc. and any use of such marks by Sauna360 is under license.

Apple® is a registered trademark of Apple Inc.

Tylö® is a registered trademark of Sauna360.

SAUNA360
HELP PEOPLE LIVE BETTER

