



TRADITIONAL SAUNA SERIES

Installation and Operating Instructions

Tylö® Halmstad™ 2

TYLÖ

THIS PAGE IS INTENTIONALLY BLANK



Sauna360 congratulates you on your decision to enjoy the finest sauna available...

Welcome to the growing family of Tylö® sauna owners.

Before you begin reviewing the manual, please take a moment to register your warranty. Doing so will assist us in contacting you for any important notification.

Prior to registering, you will need the serial number(s) located on the equipment.

To register, please go to <http://tylo.com/en-us/warranty>



FOR YOUR RECORDS

Sauna Room Model/Serial Number: _____

Control Model/Serial Number: _____

Contact Box Model/Serial Number: _____

Date Purchased: _____

Dealer: _____

Address: _____

Phone Number: _____

Website/Email: _____

If questions arise regarding this product or this manual, please contact your authorized Tylö dealership. They are trained professionals who are familiar with the product as well as new sauna ownership concerns. Their expertise will facilitate the enjoyment of your new **Tylö** sauna.

IMPORTANT: SAUNA360 reserves the right to change specifications or design without notification and without incurring any obligation.

THIS PAGE IS INTENTIONALLY BLANK

Table of Contents

SECTION 1. BEFORE YOU BEGIN	1
SECTION 2. SAFETY INFORMATION	2
2.1. CONSTRUCTION and INSTALLATION SAFETY	2
2.2. USER and OPERATIONAL SAFETY	3
SECTION 3. INSTALLATION REQUIREMENTS	4
SECTION 4. PART LIST and TOOL REQUIREMENTS	5
SECTION 5. SAUNA ROOM ASSEMBLY	6
SECTION 6. ELECTRICAL HOOK-UP	15
SECTION 7. CONTROL INSTALLATION	18
SECTION 8. OPERATING the CONTROL	19
SECTION 9. INSTALLING SAFETY PLACARDS	20
SECTION 10. PLACING SAUNA ROCKS	21
SECTION 11. HOW TO TAKE A SAUNA	22
SECTION 12. MAINTENANCE	23
SECTION 13. TROUBLESHOOTING	23
13.1. PRE-HEAT MODE	23
13.2. SENSOR NOT DETECTED	24
13.3. HIGH LIMIT ERROR	24
13.4. DOOR OPEN	25
13.5. JUMPER ERROR	25
13.6. INFORMATION	25

SECTION 1. BEFORE YOU BEGIN

This manual is for installation and operation of an Tylö® Halmstad™ 2 sauna room with Sense UB heater (1801-17-1902, 1801-22-1902) mated with a Bliss control (1601-52) and CB21-1 (1201-21-1) contactor (CB) box.



Tylö® Halmstad 2 Sauna Room



Sense UB Heater
(1801-17-1902, 1801-22-1902)

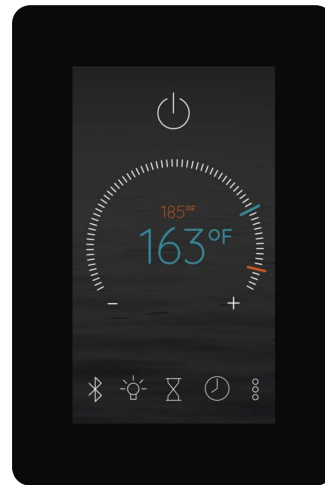

Bliss Control
(1601-52)



CB Box
CB21-1 (1201-21-1)

Figure 1.

Use these instructions when assembling the Tylö® Halmstad™ 2 sauna room. For best results and for protection of product warranty, please read, understand and follow all safety information, safety placards, and installation and operating instructions prior to starting the installation process. When completed, leave these instructions with the owner.

If questions arise regarding this product or this manual, please contact your authorized Tylö dealership. They are trained professionals who are familiar with the product as well as new sauna ownership concerns. Their expertise will facilitate the enjoyment of your new **Tylö** sauna.

SECTION 2. SAFETY INFORMATION

2.1. CONSTRUCTION and INSTALLATION SAFETY



WARNING - ELECTRIC SHOCK HAZARD: High voltage exists within this equipment. There are no user-serviceable parts within this equipment. Have the equipment installed and serviced only by qualified and licensed personnel in accordance with local and national codes.



WARNING - ELECTRIC SHOCK HAZARD: DO NOT install electrical receptacles inside the sauna room.



WARNING: If installing a fire sprinkler system inside the sauna room, ensure it is properly rated for sauna room temperatures.



CAUTION: During assembly, observe all recommended minimum safe distances between the heater and combustible materials.



CAUTION: When assembly is completed, ensure proper ventilation is provided and airflow is not restricted.



CAUTION: Loose electrical connections can cause heat damage to wires, terminal blocks and other components. Improper connections may void product warranty. Ensure all electrical connections are installed and inspected by qualified and licensed personnel.



IMPORTANT: The door to the sauna room must open outward, to the exterior of the sauna room.



IMPORTANT: DO NOT install a lock or mechanical locking device onto the door of the sauna room. If needed, use only a magnetic or spring-loaded catch mechanism that allows the door to open when pressed or pulled.



IMPORTANT: To prevent electrical shock, provide adequate electrical grounding to the electrical receptacle.



IMPORTANT: Do not install a shower in the sauna room.

NOTE: Use only approved sauna room materials for interior construction of the sauna room. Installation of unapproved materials or accessories may void product warranty

NOTE: To protect product warranty, only qualified licensed personnel should perform installation and service to this equipment.

NOTE: A GFCI (Ground-Fault Circuit Interrupter) device is not required by NEC. Only install a GFCI if required by local codes, however, be aware this will cause nuisance electrical circuit trips during use of the product.

2.2. USER and OPERATIONAL SAFETY



WARNING: Prolonged exposure to elevated temperatures can induce hyperthermia. Hyperthermia occurs when internal body temperature reaches several degrees above normal (98.6°F). Symptoms of hyperthermia include an increase in body temperature, dizziness, lethargy, drowsiness, and fainting. Effects of hyperthermia include failure to perceive heat, failure to recognize the need to exit the room, unawareness of impending hazard, fetal damage in pregnant women, physical inability to exit the room and unconsciousness.



WARNING: DO NOT take a sauna if using alcohol, recreational drugs, or prescribed medication as these may greatly increase risk of hyperthermia, personal injury or death.



WARNING - FIRE HAZARD: DO NOT use the sauna room for drying clothes, bathing suits, towels, etc. **DO NOT** hang towels above heater or place objects onto the sauna heater. Only place rocks supplied with the heater onto the heating elements. **DO NOT** place combustible materials onto the sauna heater.



WARNING - FIRE HAZARD: IMMEDIATELY DISCONTINUE using the sauna if the walls or ceiling exhibit unusual discoloration and/or darken in color.



WARNING - HOT SURFACES: The heater is extremely hot during operation. Keep hair, head, hands, body, and appendages on the safe side of guard rails. Keep children and vulnerable individuals a safe distance away from the heater. **DO NOT TOUCH** the heater while in operation as severe burns to skin may result.



WARNING - CORROSIVE: DO NOT pour chlorinated pool or spa water onto the heater as corrosion will occur and void product warranty.



WARNING: DO NOT pour excessive water onto the heater as damage may occur and void product warranty.



IMPORTANT: If pregnant or a person in poor health, consult with a physician before using sauna.



IMPORTANT: DO NOT exercise, play or roughhouse while using the sauna. Be safe and respectful of everyone.



IMPORTANT: Keep children, minors, and vulnerable individuals a safe distance away from a warming or hot sauna heater. Be a responsible sauna user. When needed, provide operating instructions to those less experienced. Keep operation of the sauna safe for yourself and others to enjoy.

NOTE: Inspect the sauna regularly. Check for maintenance of the heater, control, and benches. Replace wood surfaces should any show signs of deterioration.

SECTION 3. INSTALLATION REQUIREMENTS

To ensure safe use of the sauna room, verify the following criteria are met:

- Two (2) adults are required for the assembly and installation of the room.
- Ensure all electrical wiring is installed in accordance with NEC, state, and local codes.
- The sauna room is designed to operate on 120 Volts AC (standard household current).
- The Tylö® Halmstad™ 2 sauna room will require either 15 amp or 20 amp service. Install electrical wire that is rated appropriately to meet or exceed the *Maximum Current Load* from the electrical panel to the receptacle. For safety, do not use extension cords, undersized, or inappropriately rated wiring.

Heater Model	Maximum Current Load	Wire Rating (Minimum)
1801-17-1902 (1.7 Kw)	15 Amp	#2 14AWG +Gr
1801-22-1902 (2.2 Kw)	20 Amp	#2 12AWG +Gr

- A 120 VAC dedicated circuit is recommended to avoid unnecessary tripping of the assigned circuit breaker.
- Ensure the circuit breaker is rated to *ONLY* meet the design limit of the *Maximum Current Load*. Do not install an oversized/over-rated circuit breaker. Do not exceed the safety rating of the *Maximum Current Load*.
- Install either a NEMA 5-15R or 5-20R amp rated electrical receptacle. **DO NOT** install a 5-20R receptacle onto a 15 amp rated circuit.

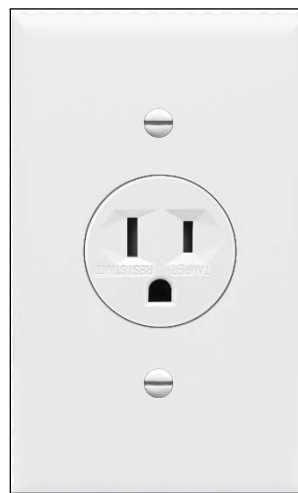

5-15R (15 Amp) Receptacle

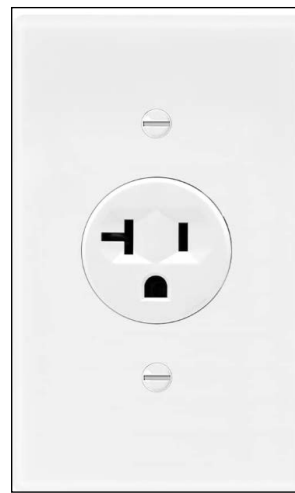

5-20R (20 Amp) Receptacle

Figure 2.

- Do not operate the sauna room should the power cord or connector become damaged or adversely discolored.
- Ventilation must comply with instructions provided in this manual.

SECTION 4. PART LIST and TOOL REQUIREMENTS

PART LIST

Inspect and verify the packaging includes the following materials.

- **Box #1:** Floor, ceiling, benches and door handle.
- **Box #2:** Left and right panels.
- **Box #3:** Front and back panels.

Each box label indicates the model of the sauna room and serial number. The label also provides a brief description of the box contents.

The hardware package with each room includes a T20 Torx bit.

Should it be necessary to contact your dealer or technical support, record the model and serial numbers from each box.

Box Number _____

Serial Number _____

Model Number _____

Box Number _____

Serial Number _____

Model Number _____





Box Number _____



Serial Number _____





Model Number _____



TOOL REQUIREMENTS

- #2 Phillips Head Screw Driver
- T20 Torx Drive
- Bubble level

<p style="text-align: center;">6000-691</p> <p style="text-align: center;">RM TRAD Tylo Halmstad 2 W/BLISS 15A 120V CB21-1 V1 SL# CSF29ABTR44-15V1-4887</p> <div style="display: flex; justify-content: space-between;"> <div style="text-align: center;">  <small>6000-691</small>  <small>CSF29ABTR44-15V1-4887</small> </div> <div style="text-align: center;"> <p>Top & Bottom Panel</p> <p>BOX 1 of 3</p> </div> </div>	<p style="text-align: center;">6000-691</p> <p style="text-align: center;">RM TRAD Tylo Halmstad 2 W/BLISS 15A 120V CB21-1 V1 SL# CSF29ABTR44-15V1-4887</p> <div style="display: flex; justify-content: space-between;"> <div style="text-align: center;">  <small>6000-691</small>  <small>CSF29ABTR44-15V1-4887</small> </div> <div style="text-align: center;"> <p style="border: 2px solid red; padding: 2px;">Side Panels</p> <p>BOX 2 of 3</p> </div> </div>
--	---

<p style="text-align: center;">6000-691</p> <p style="text-align: center;">RM TRAD Tylo Halmstad 2 W/BLISS 15A 120V CB21-1 V1 SL# CSF29ABTR44-15V1-4887</p> <div style="display: flex; justify-content: space-between;"> <div style="text-align: center;">  <small>6000-691</small>  <small>CSF29ABTR44-15V1-4887</small> </div> <div style="text-align: center;"> <p>Front & Back Panels</p> <p>BOX 3 of 3</p> </div> </div>

<p style="text-align: center;">6000-692</p> <p style="text-align: center;">RM TRAD Tylo Halmstad 2 W/BLISS 20A 120V CB21-1 V1 SL# CSF29ABTR44-20V1-4887</p> <div style="display: flex; justify-content: space-between;"> <div style="text-align: center;">  <small>6000-692</small>  <small>CSF29ABTR44-20V1-4887</small> </div> <div style="text-align: center;"> <p>Top & Bottom Panel</p> <p>BOX 1 of 3</p> </div> </div>	<p style="text-align: center;">6000-692</p> <p style="text-align: center;">RM TRAD Tylo Halmstad 2 W/BLISS 20A 120V CB21-1 V1 SL# CSF29ABTR44-20V1-4887</p> <div style="display: flex; justify-content: space-between;"> <div style="text-align: center;">  <small>6000-692</small>  <small>CSF29ABTR44-20V1-4887</small> </div> <div style="text-align: center;"> <p style="border: 2px solid red; padding: 2px;">Side Panels</p> <p>BOX 2 of 3</p> </div> </div>
--	---

<p style="text-align: center;">6000-692</p> <p style="text-align: center;">RM TRAD Tylo Halmstad 2 W/BLISS 20A 120V CB21-1 V1 SL# CSF29ABTR44-20V1-4887</p> <div style="display: flex; justify-content: space-between;"> <div style="text-align: center;">  <small>6000-692</small>  <small>CSF29ABTR44-20V1-4887</small> </div> <div style="text-align: center;"> <p>Front & Back Panels</p> <p>BOX 3 of 3</p> </div> </div>

SECTION 5. SAUNA ROOM ASSEMBLY

Use these instructions for assembling a 2-person Traditional sauna room.

LAYING THE FLOOR PANEL

1. Place the floor panel on a flat, level surface, between 3 and 6 inches away from nearby walls, and no more than 5 feet from the dedicated electrical receptacle.

Each edge of the base is labeled with numbers to correspond with the panels as they are installed. The edge labeled #4 is the FRONT of the sauna room.

2. Orient edge #4 to where you want the front of the sauna to be.
3. Using a bubble level, check the floor panel for level. If necessary, use wooden shims beneath the floor panel to make level.
4. Ensure all cables and connectors attached to the floor panel are pulled in away from the edges.

INSTALLING BACK WALL SECTION

5. Place the hangers of the back wall section into the mating hangers located on the back edge of the floor panel labeled #1.
6. Hold the back wall in place until the left wall section is installed.



Figure 3. Laying the Floor Panel



Figure 4. Installing Back Wall Section

INSTALLING LEFT WALL SECTION

7. Place the hangers of the left wall section into the mating hangers located on the left edge of the floor panel labeled #2.
8. Lift up the left wall and slide the edge brackets into the mating brackets located on the back wall.



Figure 5. Installing Left Wall Section

INSTALLING RIGHT WALL SECTION

9. Place the hangers of the right wall section into the mating hangers located on the right edge of the floor panel labeled #3.
10. Lift up the right wall and slide the edge brackets into the mating brackets located on the back wall.
11. Connect the light cable from the backrest to the mating cable from the wall.
12. Neaten up the cable and install the backrest onto the hangers on the back wall.

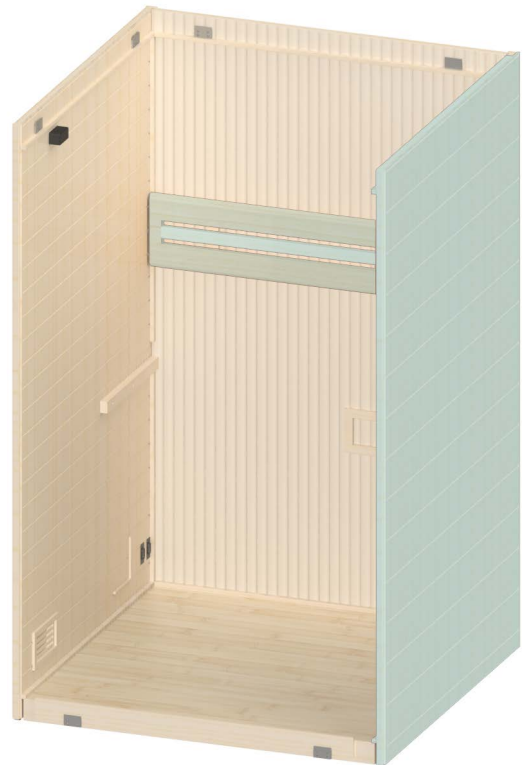

Figure 6. Installing Right Wall Section

13. When the wall panels are mated correctly, verify the top edges where the corners meet are flat and flush.

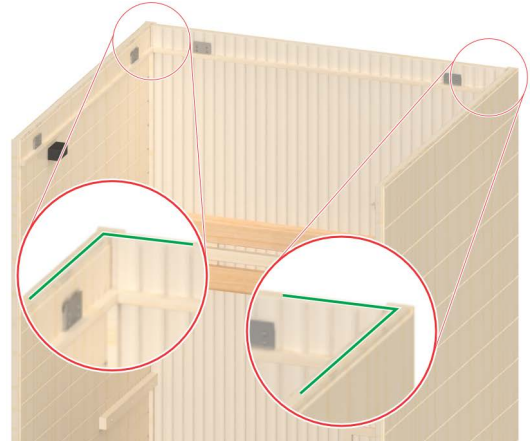

Figure 7. Verifying Flat and Flush Corners

INSTALLING CONTACTOR (CB) BOX

14. Remove the cover of the CB Box to gain access to the four (4) mounting holes located in the back of the box.
15. Set the hardware and cover aside in a safe location.
16. Position the CB Box onto the wooden “L” trim located inside of the left wall.
17. Using the four (4) 3/16” x 3/4” screws supplied with the kit, attach the CB Box to the wall.
18. Use the following sub-steps if the cable track is not already pre-installed
 - a. Remove the adhesive backing from the double-sided tape adhered on the back of the cable track.
 - b. Apply the cable track along the corner of the wall beneath the CB box.



Figure 8. Mounting the CB Box to the Wall

CONNECTING CABLES

Electrical installation must be made by a licensed electrician on accordance with the National Electric Code and local regulations.

19. Route the low voltage cables through a bottom opening located on the low voltage side on the CB box.
20. Route the power cable through a bottom opening located on the high voltage side of the CB box.
21. The sauna room wires and cables are labeled according to the terminals they connect to inside the CB box. See Figure 9.
22. For additional electrical information, see “SECTION 6. ELECTRICAL HOOK-UP” on page 15.

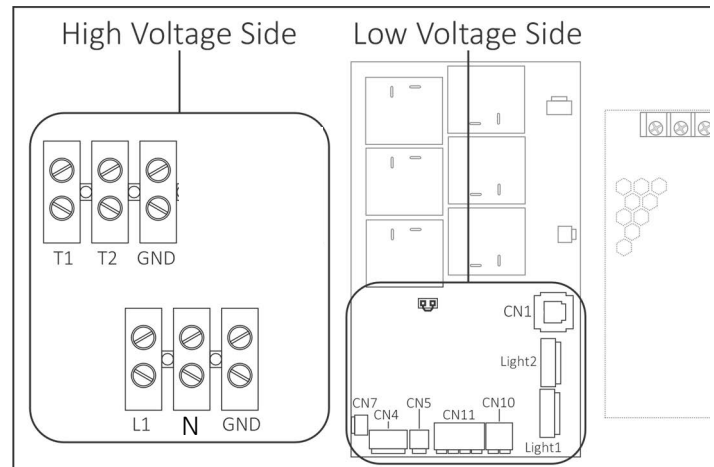

Figure 9. CB Box Interior

ASSEMBLING LOWER BENCH

Use Figure 10. for the assembly steps below.

23. Place the lower bench top down on a flat clean work surface.
24. Flip the leg brace top down and align the edge of the leg brace with the left edge of the lower bench.
25. From inside the left edge of the lower bench, use two (2) M4 x 50mm T20 Torx head screws included in the kit to attach the leg brace to the bench.

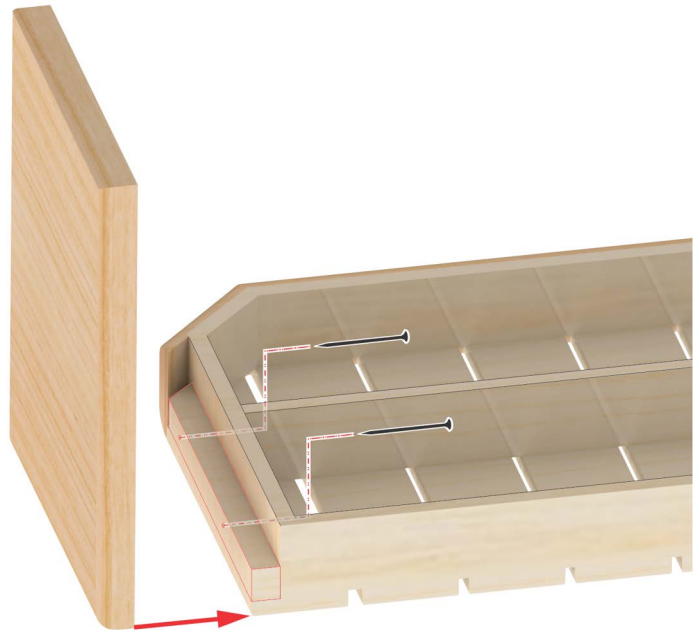

Figure 10. Assembling Lower Bench

INSTALLING BENCHES

Use Figure 11. for the installation steps below.

26. Align and slide the upper bench over the side braces located on the left and right walls and drop into place (A).
27. Connect the upper bench light cable to the mating cable on the back wall.

NOTE: For the lower bench, DO NOT rigidly attach to the bench brace (C) until all electrical work with the CB Box are completed and the panel cover is closed and screwed in place.

28. Rotate the lower bench right side up, and bring into the room.
29. Place the right edge of the lower bench onto the lower bench brace located on the right wall (B).
30. From beneath the bench, use two (2) M4 x 50mm T20 Torx head screws included in the kit to attach the lower bench to the bench brace (C).
31. Connect the lower bench light cable to the mating cable on the right wall.

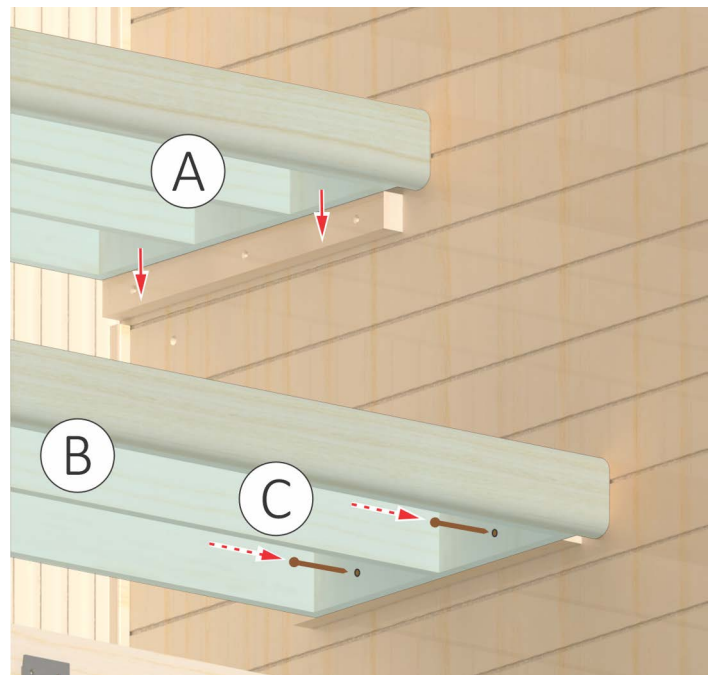

Figure 11. Installing Benches

INSTALLING FRONT WALL

32. Place the hangers of the front wall into the mating hangers located on the front of the floor panel.
33. Lift the front wall and slide the left and right brackets onto the edge brackets of the left and right walls. Press the front wall down into place.

All wall sections should now be attached and secure.

34. Verify the front wall is held securely in place by the left and right edge brackets.
35. Verify the top edge of all wall sections are level and flush.

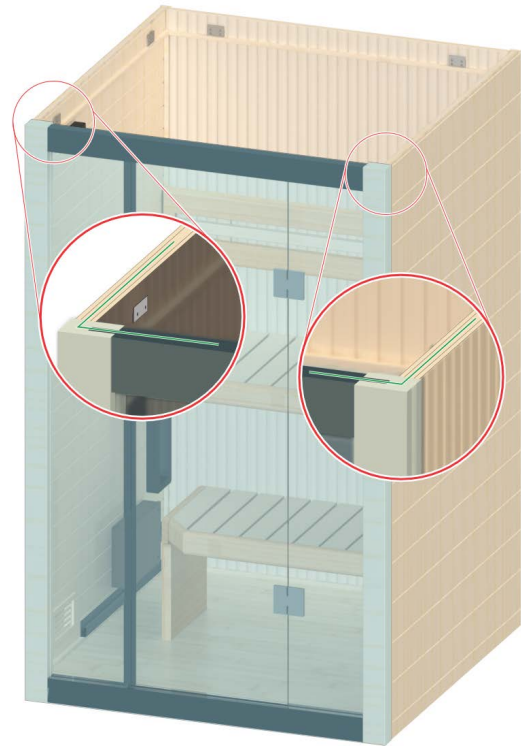

Figure 12. Installing Front Wall

INSTALLING DOOR HANDLE

36. Arrange the door handles and hardware as shown in Figure 13. Screws and cap are installed from inside the door.
37. Place the door handles on either side of the glass door, aligning with the holes in the glass.
38. Install the spacers into the holes in the glass.
39. Using the two (2) M4 x 100mm Phillips head screws included in the kit, attach the door handles to the glass door.

NOTE: Install screws by hand with a screw driver
DO NOT USE a power tool.

40. Install the caps into the ends of the handle screw holes.

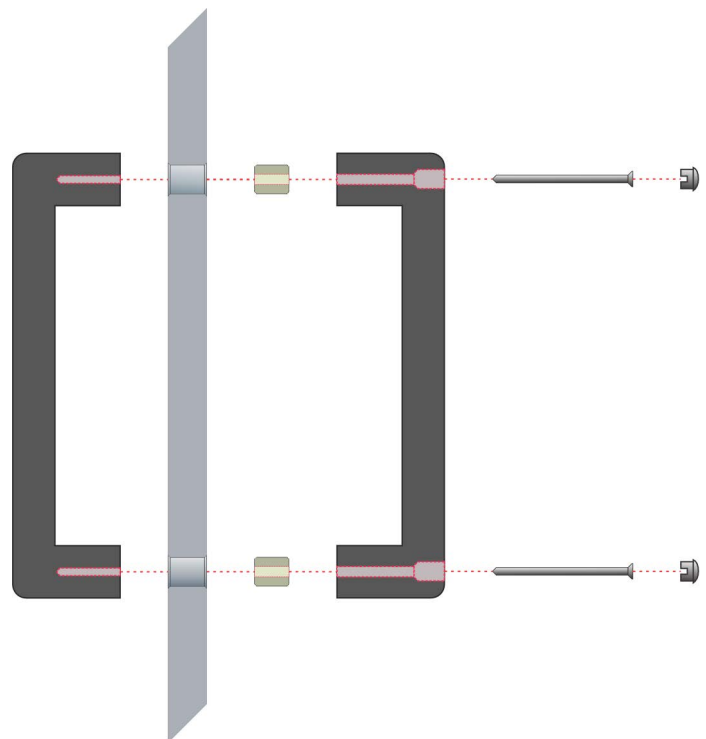

Figure 13. Installing Door Handle

INSTALLING CEILING

41. From the top of the left, right, and back wall sections, Pull the ends of the cables out and over the outside edges.
42. Lift the ceiling section and gently place it between the wall sections and lock into place on the brackets.

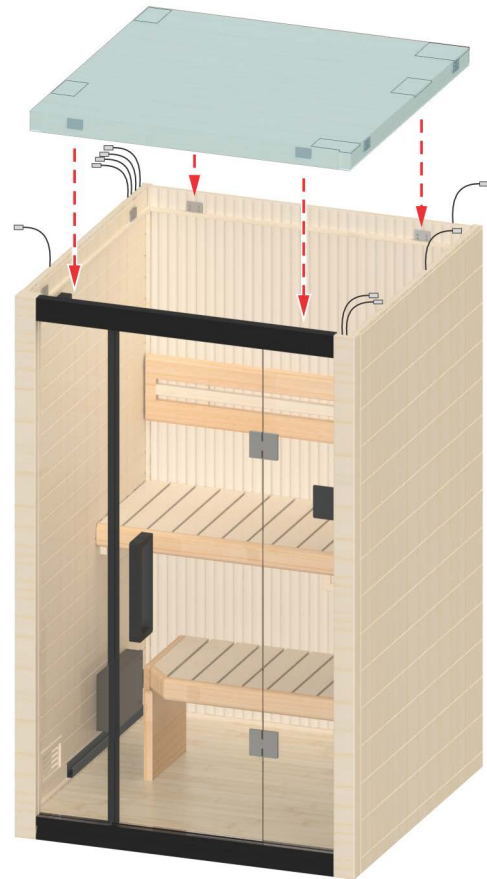

Figure 14. Installing Ceiling

43. From the top of the ceiling, open the five (5) hatches located on the left, right, and back.

ELECTRICAL CONNECTIONS - Ceiling, Left Back Corner

44. Fish out the five (5) cables from the hatch.
45. Connect the left wall CN1 cable to the CN1 ceiling cable.
46. Connect the left wall CN4 cable to the CN4 ceiling cable.
47. Connect the left wall CN6 cable to the CN6 ceiling cable.
48. Connect the left wall #6 cable to the #6 ceiling cable.
49. Connect the left wall #7 cable to the #7 ceiling cable.
50. Dress the wall cables into the trench.
51. Close the hatch.

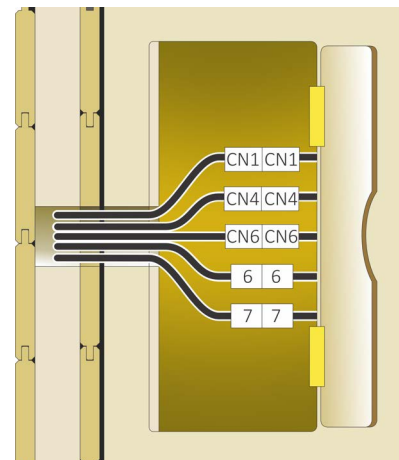

Figure 15. Ceiling, Left Back Corner

ELECTRICAL CONNECTIONS - Ceiling, Left Front Corner

52. Fish out the one (1) cable from the hatch.
53. Connect left wall CN4 cable to CN4 ceiling cable.
54. Dress the wall cable into the trench.
55. Close the hatch.

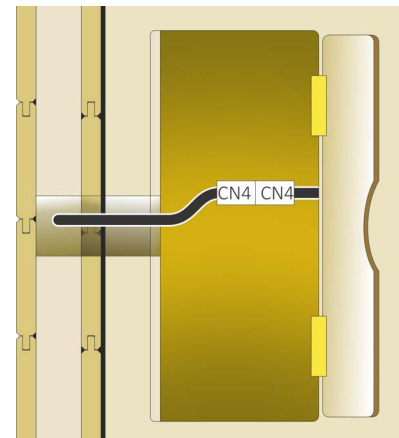

Figure 16. Ceiling, Left Front Corner

ELECTRICAL CONNECTIONS - Ceiling, Front Right Corner

56. Fish out the two (2) cables from the hatch.
57. Connect the front right #7 cable to #7 ceiling cable.
58. Connect the front right CN1 cable connector to the CN1 ceiling cable
59. Dress the corner cables into the trench.
60. Close the hatch.

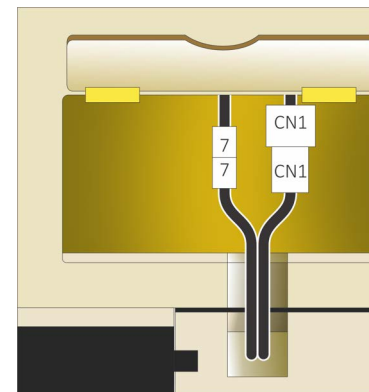

Figure 17. Ceiling, Front Right Corner

ELECTRICAL CONNECTIONS - Ceiling, Right Middle Wall

61. Fish out the one (1) cable from the hatch.
62. Connect right wall #7 cable to #7 ceiling cable.
63. Dress the wall cable into the trench.
64. Close the hatch.

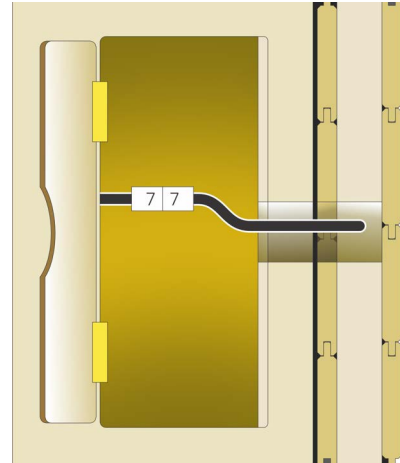

Figure 18. Ceiling, Right Middle Wall

ELECTRICAL CONNECTIONS - Ceiling, Back Right Corner

65. Fish out the two (2) cables from the hatch.
66. Connect the back wall #6 cable to #6 ceiling cable.
67. Connect the back wall #7 cable to #7 ceiling cable.
68. Dress the wall cable into the trench.
69. Close the hatch.

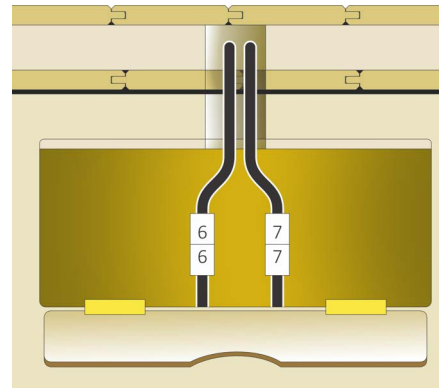

Figure 19. Ceiling, Back Right Corner

MOUNTING THE HEATER

70. Prepare the heater for installation. See the appropriate sauna heater installation and operating instruction manual.
71. Using the measurements provided in Figure 20, verify the position of the pre-drilled mounting holes for the heater.
72. Install the four (4) lag bolts (included with the heater) into the wall for mounting the heater.
73. Leave about 1/4" of the screw shaft exposed for the heater hangers to rest on.
74. Hang the heater onto the four (4) bolts, then tighten the bolts to the wall.

Instructions for electrically connecting the heater are provided later in "SECTION 6. ELECTRICAL HOOK-UP" on page 15.

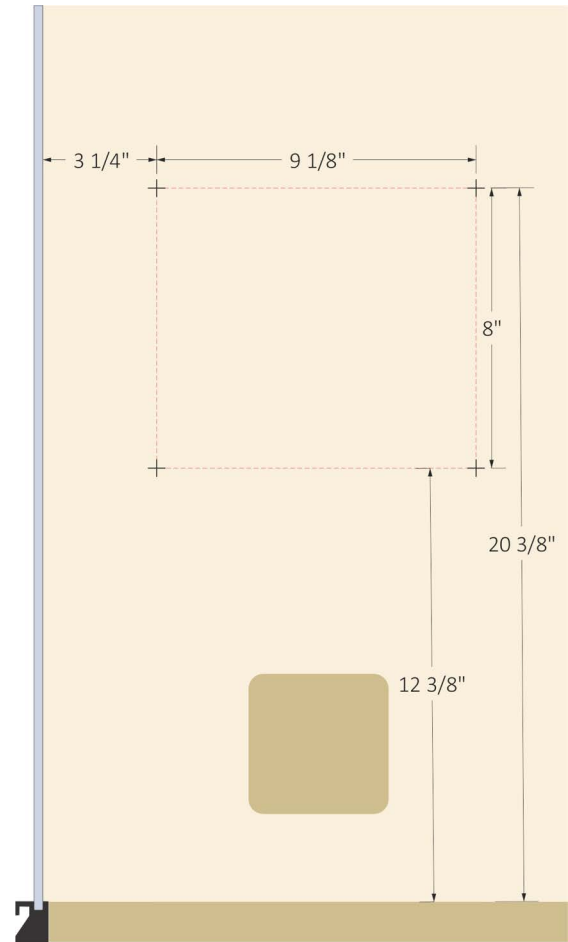

Figure 20. Heater Mounting Measurements

SECTION 6. ELECTRICAL HOOK-UP

Use Figure 21. for the following steps.

Electrical installation must be made by a licensed Electrician in accordance with the National Electric Code and local regulations.

1. Route the heater power cable through an opening located on the bottom of the CB box, high voltage side.
2. Connect wires to the correct terminals. See “DIAGRAM 1. ELECTRICAL, 120VAC 1 PHASE”.

NOTE: The heater includes a small wire harness for the high limit control. This **MUST BE CONNECTED** for safe operation of the sauna.

3. Route the high limit control wires from the sauna heater through an available hole in the bottom of the CB Box, low voltage side.

NOTE: Maintain separation of high and low voltage wires.

4. Connect the wires to the high limit terminals (CN5) on the circuit board. See “DIAGRAM 1. ELECTRICAL, 120VAC 1 PHASE”.

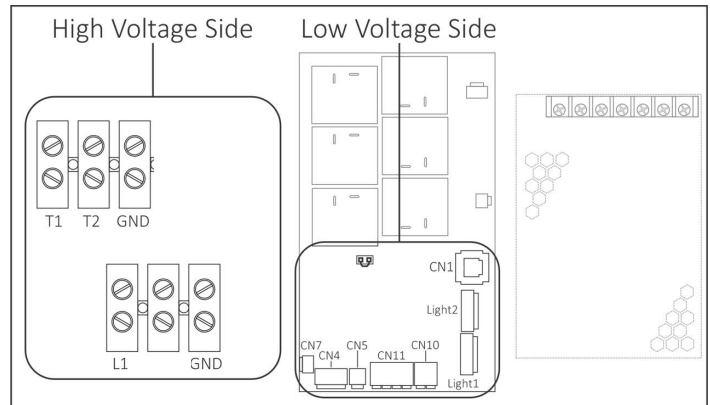

Figure 21. CB Box Interior

CONNECTING POWER

Connect the sauna room power cord into either a 15 amp / 5-15R or 20 amp /5-20R receptacle.

NOTE: Ensure the sauna room is connected to a dedicated circuit that is configured for the correct electrical rating.



WARNING: Incorrectly connecting the sauna room into a shared circuit will cause poor performance, circuit breaker tripping, and overheating of electrical wiring.



5-15R Receptacle



15 Amp Plug

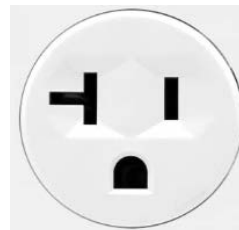

5-20R Receptacle



20 Amp Plug

Figure 22. Connecting Power

DIAGRAM 1. ELECTRICAL, 120VAC 1 PHASE

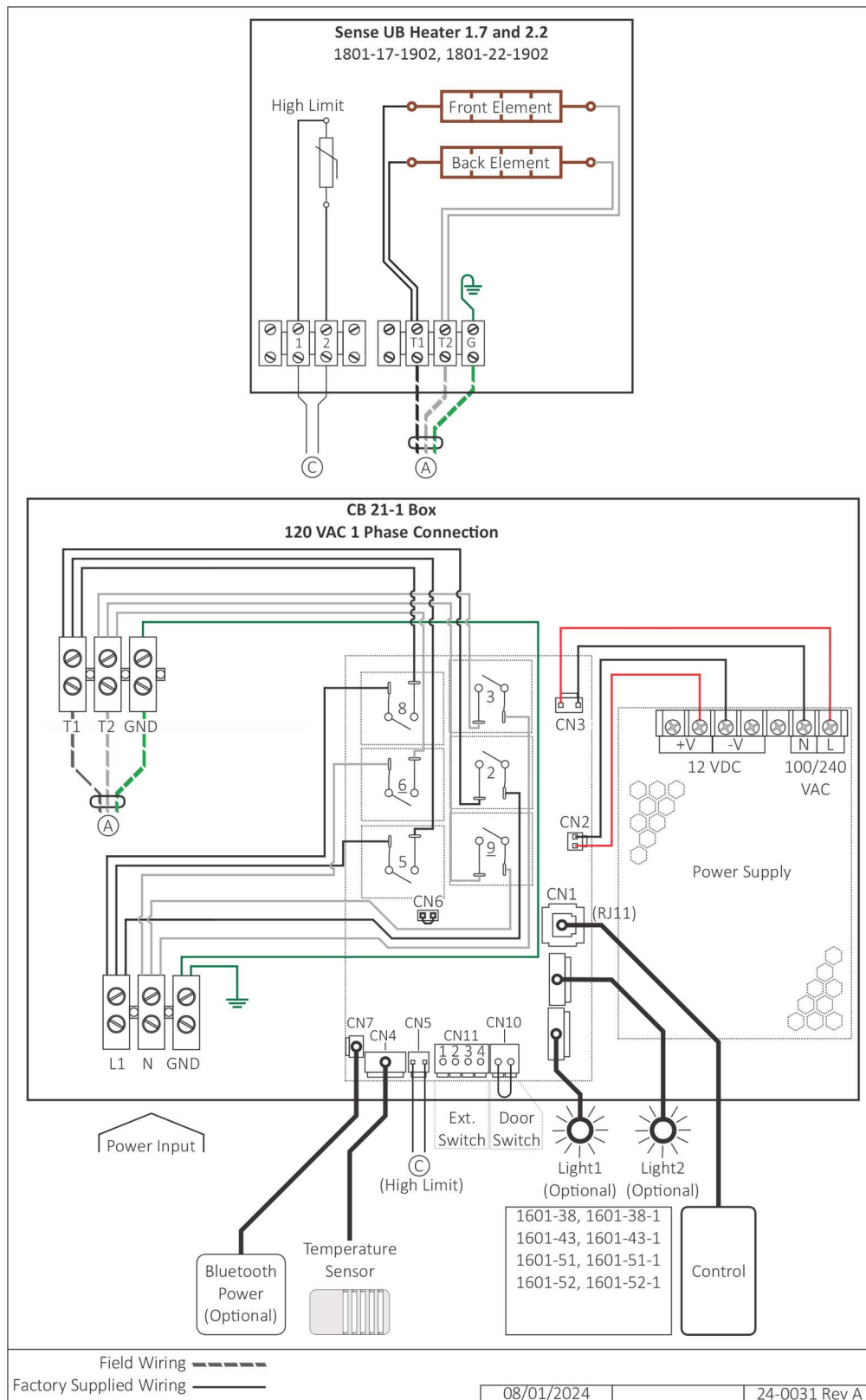
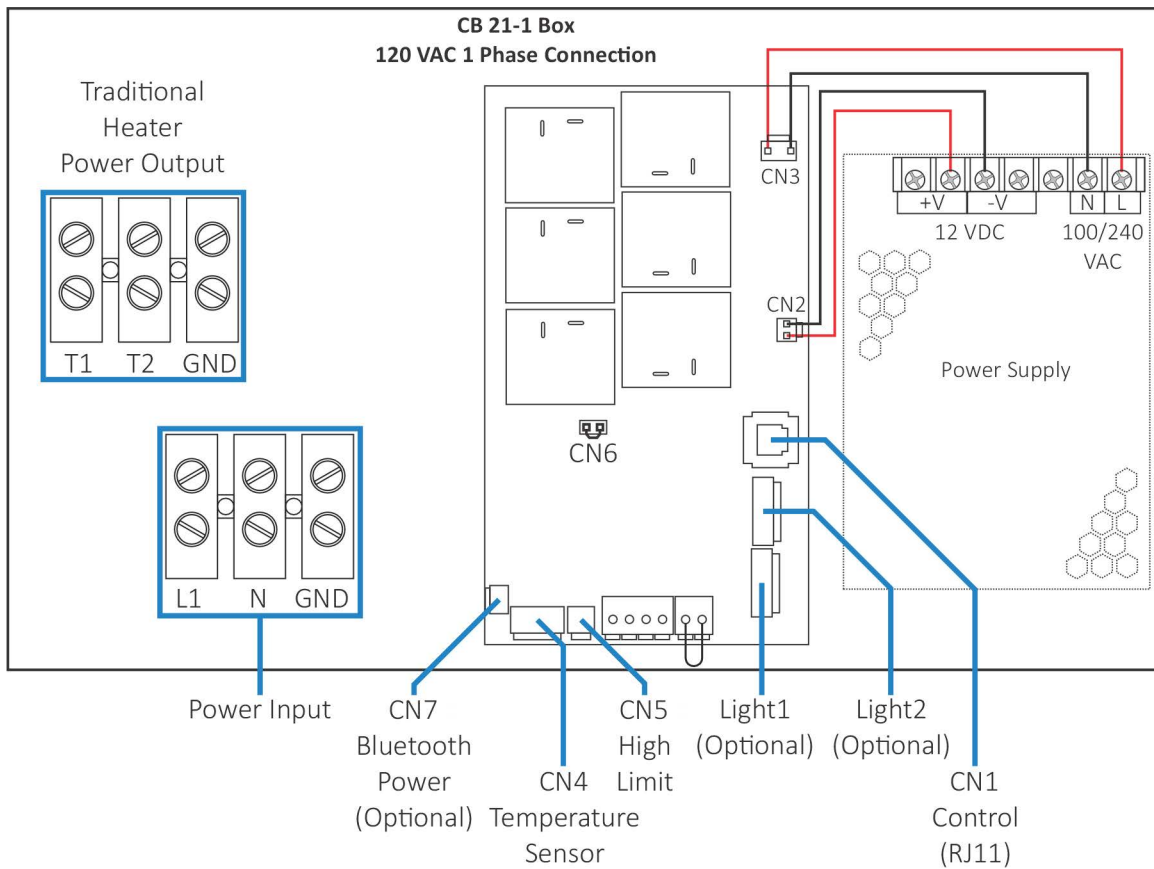

DIAGRAM 2. CB BOX INTERNAL VIEW



SECTION 7. CONTROL INSTALLATION

The Bliss control is weather resistant and water resistant, allowing it to mount either on the interior or exterior of the sauna room.

If the control was not pre-installed, use the following steps to install the control.

1. Locate the keyed circular hole in the front glass for mounting the control. The control will mount on the exterior of the glass. See Figure 23. for the remaining steps.
2. Orient the UP arrow on the back of the control (A) and insert the threaded tube through the keyed circular hole in the glass.
3. Attach the control to the glass from the interior using the threaded retaining ring (B).
4. Connect the RJ11 control cable (C) to the female RJ11 jack located inside the threaded tube of the control.
5. Neaten up the control cable, then attach the back cover (D) over the threaded retaining ring (B).

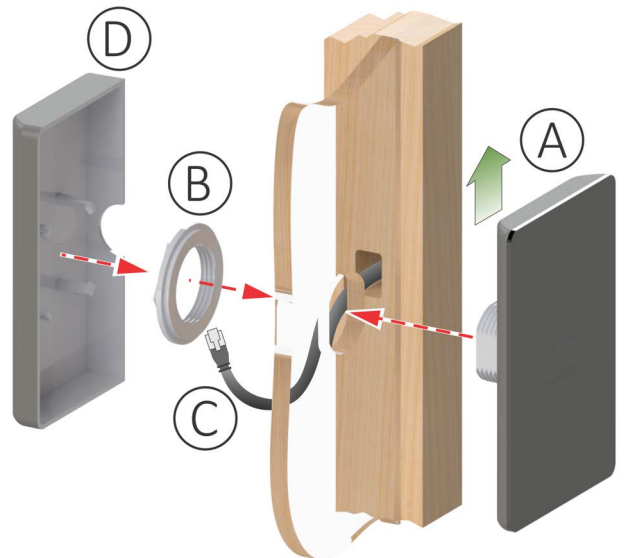

Figure 23. Installing the Control

SECTION 8. OPERATING the CONTROL

The instructions provided here are for operating a traditional sauna heater. See **Bliss Operating Instructions** for further details on the control.

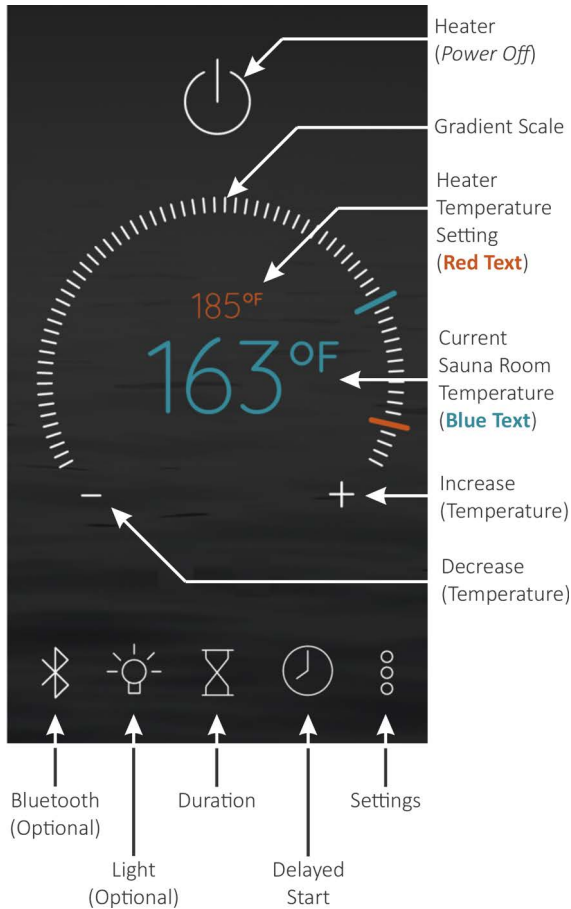

Figure 24. Control Icons

APPLYING POWER

Tap the **Power** icon once. The default settings for the temperature is 194°F, the bath time is 60 minutes. These settings are adjustable from 119° to 194°. Length of the sauna can be set from 0 to 60 minutes. The time delay before start can be up to 24 hours. Any changes are remembered by the heater for your next bath. Should the heater power be lost then restored, the settings will return to their default values.

GRADIENT SCALE

The scale is touch sensitive. Use the tip of your finger to scroll for increasing or decreasing a selected setting (i.e. temperature, duration, light color, light intensity, bluetooth audio volume).

HEATER TEMPERATURE SETTING

The temperature setting of the heater is displayed in small **red** colored text.

CURRENT SAUNA ROOM TEMPERATURE

The current sauna room temperature measured by the temperature sensor is displayed in large **blue** colored text.

INCREASE

Alternative to the gradient scale, tap the plus sign (+) icon to incrementally increase a selected setting.

DECREASE

Alternative to the gradient scale, tap the minus sign (-) icon to decrementally decrease a selected setting.

SETTINGS

Tap this icon to open the *Settings* screen.

DELAYED START

Tap this icon to open the *Delayed Start* screen.

DURATION

Tap this icon to open the *Bath Time* screen.

LIGHT (Optional)

The Bliss control can operate one(1) or two (2) optional lighting packages purchased with the system. Tap this icon to enable/disable the lights.

BLUETOOTH (Optional)

The Bliss control can operate **ONLY** an optional Bluetooth® package purchased with the system. Tap this icon to enable/disable audio.

SECTION 9. INSTALLING SAFETY PLACARDS

Three (3) metal safety placards are included inside the installation instruction envelope packaged with the sauna system.



Figure 25. Caution Placard

1. Position the CAUTION placard in plain sight on the interior wall directly above the sauna heater and attach with the two (2) screws provided.

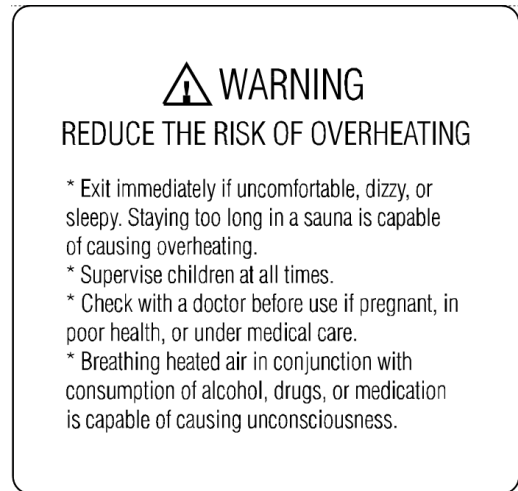

Figure 26. Warning Placard

2. Position the two (2) WARNING placards in plain sight on both sides of the doorway to the sauna.
3. Attach the placards using the eight (8) Screws provided, four (4) screws each.

SECTION 10. PLACING SAUNA ROCKS

The rocks supplied with the heater were selected with the best traditional sauna performance in mind.



HEAVY OBJECT: A full container of rocks is heavy. To avoid injury, bend at the knees when picking up the box.

- Use of other rock types may void heater warranty.
- **NEVER** operate heater without rocks in place!
- **RINSE** rocks with water before placing in the heater.

CAREFULLY place rocks loosely around the heater elements to allow efficient air circulation.

1. Remove the heater guard from the top of the heater.

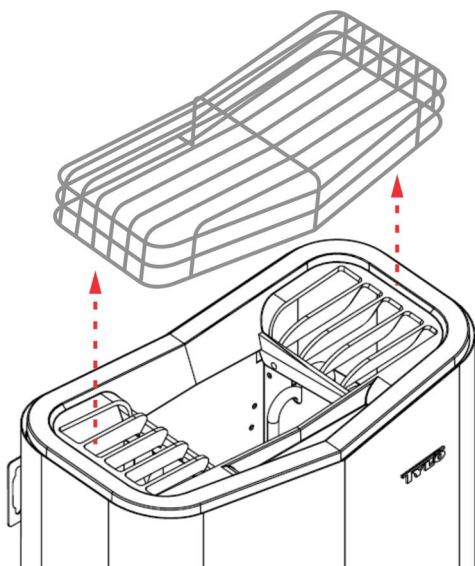

Figure 27. Removing Heater Guard

2. For the first layers, place smaller rocks around the outer perimeter of the heating elements.
3. Fill the middle sections with larger rocks.
4. Ensure the elements stay vertical while carefully filling the heater with rocks.
5. Place rocks loosely in the center of heater to allow heat to rise easily up the middle of heater.
6. Loosely cover the tops of all elements with rocks.

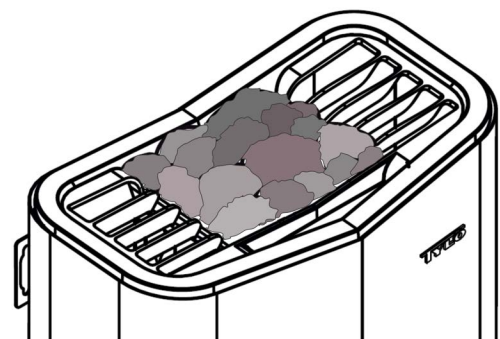

Figure 28. Placing Rocks on Top of Elements

7. Be careful not to pack the rocks too densely on top of the heater elements or onto the side chambers as this can impede airflow.

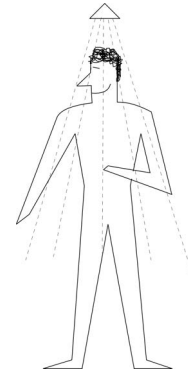

Figure 29. Do Not Pack Rocks Too Densely

8. Re-install the heater guard with the screws removed previously.

SECTION 11. HOW TO TAKE A SAUNA

- Devote adequate time to completely relax while taking a sauna bath.
- Remove clothing and jewelry. Apply a towel loosely about the body.
 - To enjoy the soothing effect of steam, splash a small amount of water onto the heated sauna rock.
 - Use one dipper full (approximately 1/2 cup) of clean water at a time, keeping exposed skin clear of the steam as it rises off the rocks.
 - **DO NOT** use chlorinated pool or spa water, as corrosion damage may result.
 - **DO NOT** smoke, exercise or drink alcoholic beverages while in the sauna room.
- After ten (10) minutes or when perspiration begins, exit from the sauna, relax in the dressing area, followed by a cool shower.
- Stay hydrated, drinking water is best.
- The allotted cool down time should equal the amount of time occupying the sauna.
- Step back into the sauna room and remain for five (5) or ten (10) minutes.
- Repeat the cycle two (2) or three (3) more times. End with a brisk shower, rinsing in cool water.
- Put on clothing only when perspiration has stopped and the body is completely dry.



Shower



Sauna Bathe

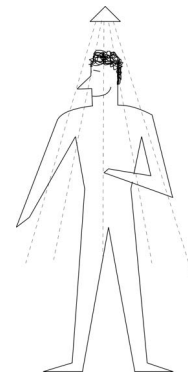

Shower

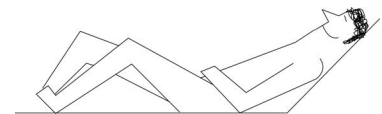

Rest/Relax



Hydrate

SECTION 12. MAINTENANCE

Inspect sauna room at the end of each day the room to ensure the control and system is off.

The sauna, like a bathroom, should be kept clean and odor free. Towels or mats should always be used on benches and floor as perspiration otherwise penetrates the soft wood. To clean and remove perspiration stains, use soap or detergent in warm water, best applied with a scrub brush. Badly soiled surfaces may require sanding. Sand paper wrapped around a wooden block works well.

Air out the sauna often by keeping the door and vents open when the sauna is not in use. Saunas that are in daily use should be washed down at least once a week to keep them clean and the air fresh. Duck board should be removed from the sauna, the sauna floor mopped and dried in a conventional manner, and the duck board thoroughly scrubbed and dried before returning to the sauna room. The sauna heater should be wiped down occasionally with a damp cloth to remove lint and dust. The rocks should be removed once a year for cleaning and small or crumbled rocks replaced.

Benches and supporting structure must be inspected annually for potential deterioration due to age, dry rot or abuse. Any boards with signs of deteriorations should be replaced immediately to avoid possible injury.

SECTION 13. TROUBLESHOOTING

Should you need to contact the dealer or outlet you purchased the product, please have the model and type numbers of the heater, CB Box and control available prior to calling.

13.1. PRE-HEAT MODE

If the air temperature inside the sauna is below 10°F (-12°C) at startup, or if the temperature sensor is not detected, the *CAUTION Pre-Heat Mode* screen appears.

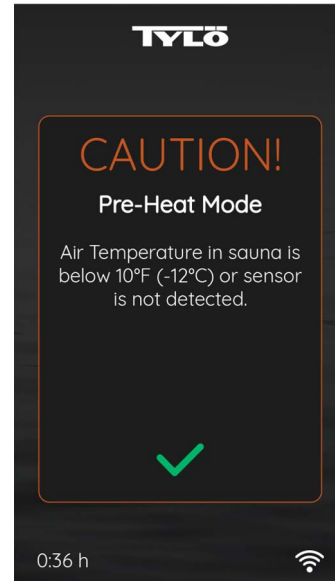

Figure 30. CAUTION Pre-Heat Mode Screen

1. Allow the heater to run for 5 minutes.
 - If the sensor is recognized, the CAUTION screen will go away.
 - If after 5 minutes the sensor is not recognized, the *WARNING Sensor Not Detected* screen appears. and the heater turns off.

13.2. SENSOR NOT DETECTED

When the sensor is not detected, power to the heater is disabled.

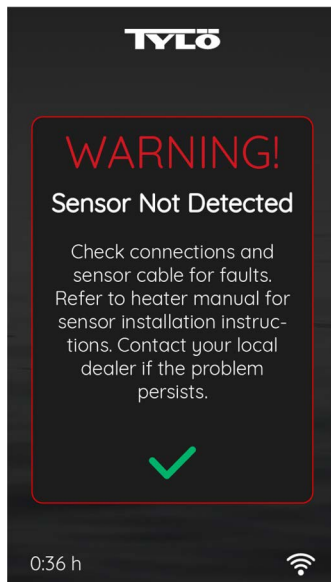

Figure 31.

1. Before performing a visual inspection, turn off circuit breakers to the sauna to remove all electrical power.
2. Refer to the content of the associated **Heater Installation and Operating Instructions** for details on the temperature sensor, cable and CB Box.
3. Check sensor electrical connections at the CB Box and at the sensor, looking for loose or broken wires, loose, corroded, or tarnished connections.
4. Inspect condition of the sensor circuit board for corrosion, tarnish and cold solder joints.
5. If the condition of the circuit board and electrical connections look good, then inspect the whole length of the sensor cable for visible damage.
6. When the inspection is completed and any user-fixable issues are corrected, re-apply power and test the operation of the sauna.
7. If the problem persists, contact your dealer.

13.3. HIGH LIMIT ERROR

When the high limit switch trips/activates, power to the heater is disabled.

While the heater is on and if the temperature at the heater rises above the high limit threshold, the heater shuts off, an audible control alarm is sounded, and the *WARNING High Limit Error* screen appears.

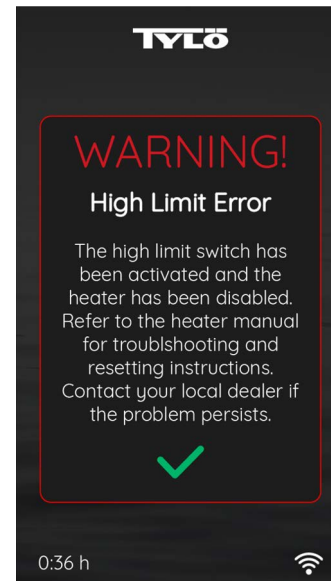

Figure 32.

1. Tap the green colored check mark.
 - The audible alarm turns off and the Home screen with heater off appears.
 - All icons on the Home screen remain functional, except for the **Power** icon.
2. Wait until temperature drops below the low temperature threshold and the high limit resets.
 - If the **Power** icon is tapped before the high limit has had time to reset, the WARNING High Limit Error screen will re-appear.
3. After the high limit has reset, tap the **Power** icon to turn the heater back on.
4. Refer to the content of the associated **Heater Installation and Operating Instructions** for details on sauna ventilation, how the heater is mounted, and placing sauna rocks to diagnose and correct the trouble. If the problem persists, contact your dealer.

13.4. DOOR OPEN

If an optional door switch (not provided by Sauna360) is installed, this message occurs when the control detects the sauna door is open for longer than 30 seconds.

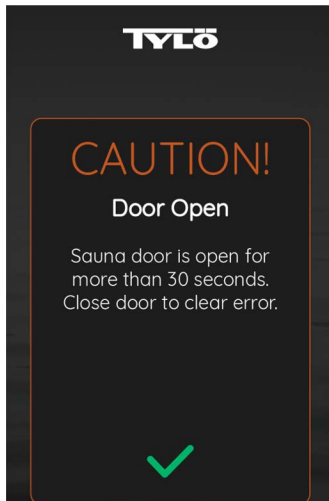

Figure 33. CAUTION Door Open

Close the door within two (2) minutes and the current sauna session will continue and the error message will go away.

If the door is open for greater than two (2) minutes, the **WARNING Door Open** screen appears and power to the heater is disabled.

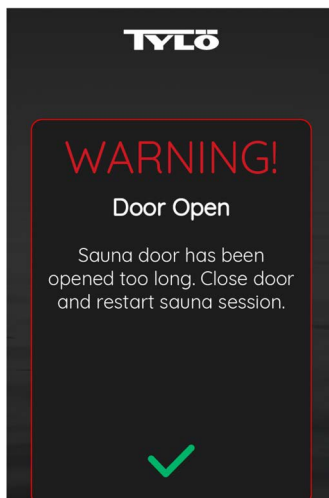

Figure 34. WARNING Door Open

Close the sauna door and press the green check mark, the Home Screen screen appears.

Press the **Power** icon to restart the sauna session.

13.5. JUMPER ERROR

This error occurs when the control detects an electrical jumper is open on the main board located in the CB Box.

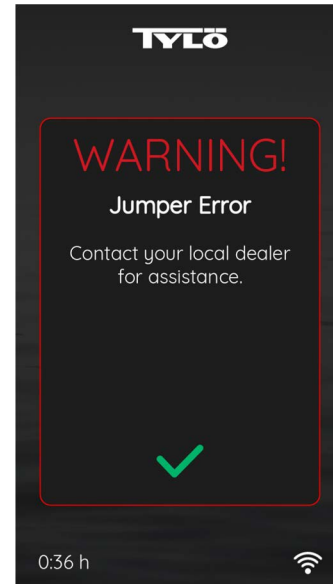

Figure 35.

There are no user-serviceable parts inside the CB Box. Shut off the breakers to the sauna and contact your dealer for assistance.

13.6. INFORMATION

When this message appears, tap the green check mark. Before inspecting, turn off the heater and allow the rocks to cool down before inspection/replacement.

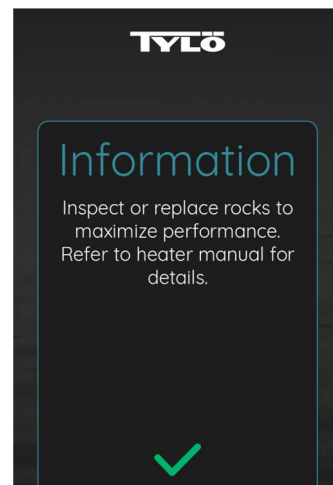

Figure 36.

©2024 Sauna360 Inc.

The Bluetooth® word mark and logos are registered trademarks owned by Bluetooth SIG, Inc. and any use of such marks by Sauna360 is under license.

Apple® is a registered trademark of Apple Inc.

Tylö® is a registered trademark of Sauna360.

SAUNA360
HELP PEOPLE LIVE BETTER

