



OUTDOOR SAUNA SERIES

Installation and Operating Instructions

Tylö® Luleå™ 3

Tylö® Luleå™ 4

TYLÖ

THIS PAGE IS INTENTIONALLY BLANK



Sauna360 congratulates you on your decision to enjoy the finest sauna available...

Welcome to the growing family of Tylö® sauna owners.

Before you begin reviewing the manual, please take a moment to register your warranty. Doing so will assist us in contacting you for any important notification.

Prior to registering, you will need the serial number(s) located on the equipment.

To register, please go to <http://tylo.com/en-us/warranty>



FOR YOUR RECORDS

Sauna Room Model/Serial Number: _____

Control Model/Serial Number: _____

Contactor Box Model/Serial Number: _____

Date Purchased: _____

Dealer: _____

Address: _____

Phone Number: _____

Website/Email: _____

If questions arise regarding this product or this manual, please contact your authorized *Tylö* dealership. They are trained professionals who are familiar with the product as well as new sauna ownership concerns. Their expertise will facilitate the enjoyment of your new *Tylö* sauna.

IMPORTANT: SAUNA360 reserves the right to change specifications or design without notification and without incurring any obligation.

THIS PAGE IS INTENTIONALLY BLANK

Table of Contents

SECTION 1. BEFORE YOU BEGIN	1
SECTION 2. SAFETY INFORMATION	2
2.1. CONSTRUCTION and INSTALLATION SAFETY	2
2.2. USER and OPERATIONAL SAFETY	3
SECTION 3. INSTALLATION REQUIREMENTS	4
SECTION 4. PART LIST and TOOL REQUIREMENTS	5
4.1. Luleå™ 3 Parts List	5
4.2. Luleå™ 4 Parts List	6
SECTION 5. SAUNA ROOM ASSEMBLY	8
SECTION 6. INSTALLING METAL FASCIA and ROOFING	22
SECTION 7. ELECTRICAL HOOK-UP	29
SECTION 8. CONTROL INSTALLATION	32
SECTION 9. OPERATING the CONTROL	33
SECTION 10. INSTALLING SAFETY PLACARDS	34
SECTION 11. PLACING SAUNA ROCKS	35
SECTION 12. HOW TO TAKE A SAUNA	36
SECTION 13. MAINTENANCE	37
SECTION 14. TROUBLESHOOTING	37
14.1. PRE-HEAT MODE	37
14.2. SENSOR NOT DETECTED	38
14.3. HIGH LIMIT ERROR	38
14.4. DOOR OPEN	39
14.5. JUMPER ERROR	39
14.6. INFORMATION	39

SECTION 1. BEFORE YOU BEGIN

This manual is for installation and operation of an Luleå™ Sauna Room with Sense UB heater (1801-83-1902) mated with a Bliss control (1601-52 | 1601-52-1) and CB 23-1 (12-23-1) contactor (CB) box.



**Luleå™ 3 Sauna Room
OR
Luleå™ 4 Sauna Room**



Sense UB Heater
(1801-83-1902)

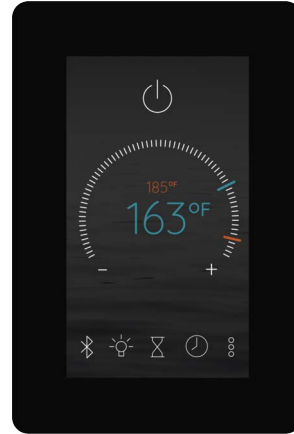

Bliss Control
(1601-52 | 1601-52-1)



CB Box
CB 23-1 (12-23-1)

Figure 1.

Use these instructions when assembling the Luleå™ Sauna Room. For best results and for protection of product warranty, please read, understand and follow all safety information, safety placards, and installation and operating instructions prior to starting the installation process. When completed, leave these instructions with the owner.

If questions arise regarding this product or this manual, please contact your authorized *Tylö* dealership. They are trained professionals who are familiar with the product as well as new sauna ownership concerns. Their expertise will facilitate the enjoyment of your new *Tylö* sauna.

SECTION 2. SAFETY INFORMATION**2.1. CONSTRUCTION and INSTALLATION SAFETY**

WARNING - ELECTRIC SHOCK HAZARD: High voltage exists within this equipment. There are no user-serviceable parts within this equipment. Have the equipment installed and serviced only by qualified and licensed personnel in accordance with local and national codes.



WARNING - ELECTRIC SHOCK HAZARD: DO NOT install electrical receptacles inside the sauna room.



WARNING: If installing a fire sprinkler system inside the sauna room, ensure it is properly rated for sauna room temperatures.



CAUTION: During assembly, observe all recommended minimum safe distances between the heater and combustible materials. Recheck all measurements to verify minimum safe distances are maintained.



CAUTION: When assembly is completed, ensure proper ventilation is provided and airflow is not restricted.



CAUTION: Loose electrical connections can cause heat damage to wires, terminal blocks and other components. Improper connections may void product warranty. Ensure all electrical connections are installed and inspected by qualified and licensed personnel.



IMPORTANT: The door to the sauna room must open outward, to the exterior of the sauna room.



IMPORTANT: DO NOT install a lock or mechanical locking device onto the door of the sauna room. If needed, use only a magnetic or spring-loaded catch mechanism that allows the door to open when pressed or pulled.



IMPORTANT: To prevent electrical shock, provide adequate electrical grounding to the electrical receptacle.



IMPORTANT: Do not install a shower in the sauna room.

NOTE: Use only approved sauna room materials for interior construction of the sauna room. Installation of unapproved materials or accessories may void product warranty

NOTE: To protect product warranty, only qualified licensed personnel should perform installation and service to this equipment.

NOTE: A GFCI (Ground-Fault Circuit Interrupter) device is not required by NEC. Only install a GFCI if required by local codes, however, be aware this will cause nuisance electrical circuit trips during use of the product.

2.2. USER and OPERATIONAL SAFETY



WARNING: Prolonged exposure to elevated temperatures can induce hyperthermia. Hyperthermia occurs when internal body temperature reaches several degrees above normal (98.6°F). Symptoms of hyperthermia include an increase in body temperature, dizziness, lethargy, drowsiness, and fainting. Effects of hyperthermia include failure to perceive heat, failure to recognize the need to exit the room, unawareness of impending hazard, fetal damage in pregnant women, physical inability to exit the room and unconsciousness.



WARNING: DO NOT take a sauna if using alcohol, recreational drugs, or prescribed medication as these may greatly increase risk of hyperthermia, personal injury or death.



WARNING - FIRE HAZARD: DO NOT use the sauna room for drying clothes, bathing suits, towels, etc. **DO NOT** hang towels above heater or place objects onto the sauna heater. Only place rocks supplied with the heater onto the heating elements. **DO NOT** place combustible materials onto the sauna heater.



WARNING - FIRE HAZARD: IMMEDIATELY DISCONTINUE using the sauna if the walls or ceiling exhibit unusual discoloration and/or darken in color.



WARNING - HOT SURFACES: The heater is extremely hot during operation. Keep hair, head, hands, body, and appendages on the safe side of guard rails. Keep children and vulnerable individuals a safe distance away from the heater. **DO NOT TOUCH** the heater while in operation as severe burns to skin may result.



WARNING - CORROSIVE: DO NOT pour chlorinated pool or spa water onto the heater as corrosion will occur and void product warranty.



WARNING: DO NOT pour excessive water onto the heater as damage may occur and void product warranty.



IMPORTANT: If pregnant or a person in poor health, consult with a physician before using sauna.



IMPORTANT: DO NOT exercise, play or roughhouse while using the sauna. Be safe and respectful of everyone.



IMPORTANT: Keep children, minors, and vulnerable individuals a safe distance away from a warming or hot sauna heater. Be a responsible sauna user. When needed, provide operating instructions to those less experienced. Keep operation of the sauna safe for yourself and others to enjoy.

NOTE: Inspect the sauna regularly. Check for maintenance of the heater, control, and benches. Replace wood surfaces should any show signs of deterioration.

SECTION 3. INSTALLATION REQUIREMENTS

To ensure safe use of the sauna room, verify the following criteria are met:

- Install this sauna room on a solid, flat, level surface that will support the combined weight of the sauna room and maximum occupant capacity. The manufacturer recommends a flat, level concrete pad of appropriate thickness (consult with local building codes), or equivalent platform, that will support the entire floor area of the sauna room.
- Maintain a clearance of 24 inches (minimum) from structures and greenery (i.e. trees, shrubs). Consult local building codes for further clearances that may apply.

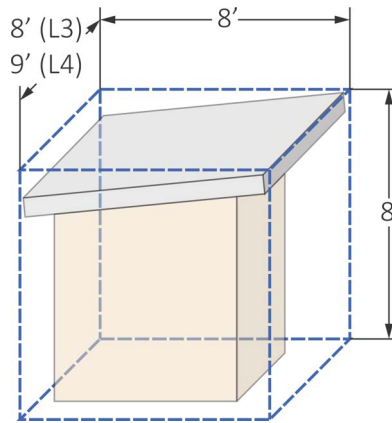

Figure 2. Sauna Room Area

- As an outdoor room, the structure requires a secure anchorage to withstand local weather extremes. Consult local building codes for approved anchoring methods and materials.
- At least three (3) adults are required for the assembly and installation of the sauna room.
- Ensure all electrical wiring is installed in accordance with NEC, state, and local codes. Installation of high-voltage wiring must be completed by a licensed Electrician.
- The sauna room is designed to operate on 240 Volts AC single phase power.
- The Sense UB (1801-83-1902) heater requires 35 amp service. Install electrical wire that is rated appropriately to meet or exceed the *Maximum Current Load* from the electrical panel to the contactor (CB) box of the sauna room.

Heater Model	KW	Maximum Current Load	Minimum Wire Rating From Power Supply to CB Box	Minimum Wire Rating From CB Box to Heater
1801-83-1902	8.3	34.6 Amp	#2 8AWG +Gr	#2 8AWG +Gr

- A dedicated 240 VAC circuit is recommended to avoid unnecessary tripping of the assigned circuit breaker.
- Ensure the circuit breaker is rated to *ONLY* meet the design limit of the *Maximum Current Load*. Do not install an oversized/over-rated circuit breaker. Do not exceed the safety rating of the *Maximum Current Load*.
- Provide adequate grounding from the electrical supply panel to the CB box.



IMPORTANT: The **EXTERIOR WOOD** surfaces of this sauna room require adequate coatings of primer and a desired paint color or stain and clear UV resistant finish to protect the exposed wood from weather and elements of the environment. **DO NOT** apply paint, stain, or other finish coatings onto the interior wood surfaces.

- When installation is complete, ensure the inlet and exhaust vents are open and free from blockage and obstructions.

SECTION 4. PART LIST and TOOL REQUIREMENTS

PART LIST

Before starting the assembly process, inspect packaging and verify contents. The hardware package with each room includes a T20 Torx bit.

4.1. Lulea™ 3 Parts List

Itm No.	Description	QTY
1	FLOOR, RM, TYLO LULEA, OUTDOOR, 5 X 6	1
2	PANEL 1, RM, TYLO LULEA, OUTDOOR, 5 X 6	1
3	PANEL 2, RM, TYLO LULEA, OUTDOOR, 5 X 6	1
4	PANEL 3, RM, TYLO LULEA, OUTDOOR, 5 X 6	1
5	PANEL 4, RM, TYLO LULEA, OUTDOOR, 5 X 6	1
6	PANEL 5, RM, TYLO LULEA, OUTDOOR, 5 X 6	1
7	PANEL 6, RM, TYLO LULEA, OUTDOOR, 5 X 6	1
8	PANEL, FRONT WALL FRAME, LULEA 3, 5 X 6, ASSY	1
9	PANEL 9, RM, TYLO LULEA, OUTDOOR, 5 X 6	1
10	PANEL 10, RM, TYLO LULEA, OUTDOOR, 5 X 6	1
11	BENCH, LOWER, HEMLOCK, HT, 20", RM, TYLO LULEA, OUTDOOR, 5 X 6	1
12	BENCH, UPPER, HEMLOCK, HT, 24" RM, TYLO LULEA, OUTDOOR, 5 X 6	1
13	BACKREST, 3-BAR, HT, RM, TYLO LULEA, OUTDOOR, 5 X 6	1
14	GLASS, SL, 5/16" (8mm), 19-1/4" x 83-1/8", DRK GREY, W/HOLES	2
15	CONTROL, BLISS	1
16	HANDLE, NO LOGO, KIT	1
	Hardware Package	1

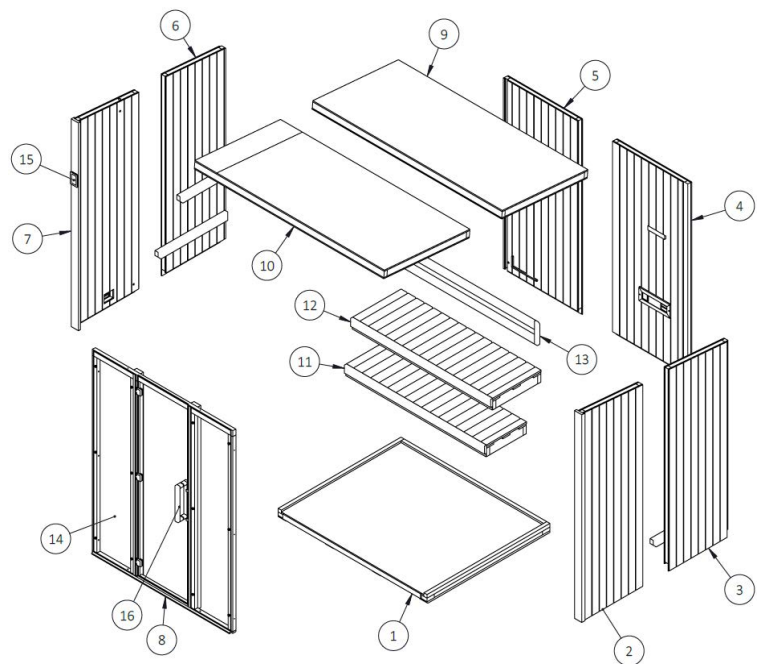

4.2. Lulea™ 4 Parts List

Itm No.	Description	QTY
1	FLOOR, RM, TYLO LULEA, OUTDOOR, 5 X 7	1
2	PANEL 1, RM, TYLO LULEA, OUTDOOR, 5 X 7	1
3	PANEL 2, RM, TYLO LULEA, OUTDOOR, 5 X 7	1
4	PANEL 3, RM, TYLO LULEA, OUTDOOR, 5 X 7	1
5	PANEL 4, RM, TYLO LULEA, OUTDOOR, 5 X 7	1
6	PANEL 5, RM, TYLO LULEA, OUTDOOR, 5 X 7	1
7	PANEL 6, RM, TYLO LULEA, OUTDOOR, 5 X 7	1
8	PANEL 7, RM, TYLO LULEA, OUTDOOR, 5 X 7	1
9	PANEL 9, RM, TYLO LULEA, OUTDOOR, 5 X 7	1
10	PANEL 10, RM, TYLO LULEA, OUTDOOR, 5 X 7	1
11	ARMREST, RM, TYLO LULEA, OUTDOOR, 5 X 7	1
12	BENCH UPPER HEMLOCK, HT, 24", RM, TYLO LULEA, OUTDOOR, 5 X 7	1
13	BENCH, RETURN, HEMLOCK, HT, 24", RM, TYLO LULEA, OUTDOOR, 5 X 7	1
14	BENCH, LOWER, HEMLOCK, HT, 20", RM, TYLO LULEA, OUTDOOR, 5 X 7	1
15	BACKREST, REAR, 3-BAR, HT, RM, TYLO LULEA, OUTDOOR, 5 X 7	1
16	BACKREST, RETURN, 3-BAR, HT, RM, TYLO LULEA, OUTDOOR, 5 X 7	1
17	GLASS, SL, 5/16" (8MM), 25-14" X 83-1/8", DRK GREY, W/HOLES	2
18	CONTROL, BLISS	1
19	HANDLE, NO LOGO, KIT	1
	Hardware Package	1

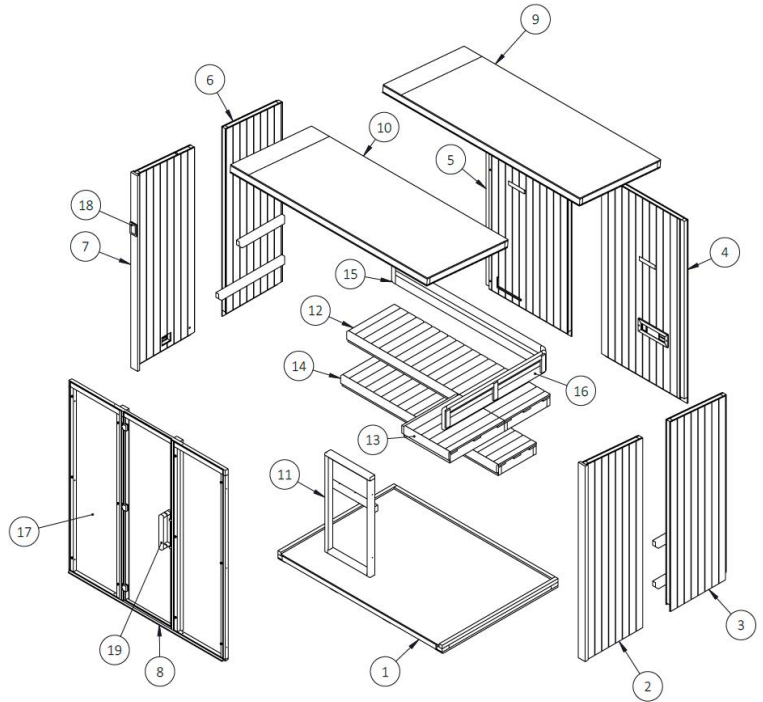

Should it become necessary to contact your dealer for assistance, record the model and serial numbers of the room, heater, contactor box, and control.

Room Model _____

Serial Number _____

Heater Model _____

Serial Number _____

Contactor Box Model _____

Serial Number _____

Control Model _____

Serial Number _____

TOOL REQUIREMENTS

- Box knife
- #2 Phillips Head Screw Driver
- T20 and T15 Torx Drive
- 1/4" socket head drive
- Bubble level
- Two (2) glass lifting suction cups
- Roll of blue painter's tape
- Tin snips
- 5" Hand Seamer
- 2.8 oz. Squeeze Tube of Silicone Door and Window Sealant
- Pneumatic Brad Nailer (16/18 Gage)
- Package of 16 gage x 2" nails
- Package of 18 gage X 1 1/2" nails.
- Miter saw/Circular saw
- Jigsaw
- Non-marring Rubber Mallet

SECTION 5. SAUNA ROOM ASSEMBLY

Use these instructions for assembling a Lulea 3 and Lulea 4 Traditional **OUTDOOR** sauna room. For ease of illustration, instructions are written for the Lulea 4 sauna room.

LAYING THE FLOOR PANEL

1. Place the floor panel on a flat, level surface, **at least** 24 inches away from adjacent walls. Consult local building codes as actual distance and safety requirements may vary.
 - The base rails around three (3) sides of the floor panel are labeled with numbers to correspond with wall panels as they are installed.
2. Orient the black colored edge of the floor panel to where you want the front of the sauna to be.
3. Using a bubble level, check the floor panel for level. If necessary, use wooden shims beneath the floor panel to make level.
4. Anchor the floor to the pad/platform on which it rests. Consult local building codes for approved anchoring methods and materials.

INSTALLING BACK-RIGHT CORNER WALL SECTIONS

5. Place wall #2 onto the base rail labeled #2.
6. Hold wall #2 upright while wall #3 is placed.
7. Place wall #3 onto the base rail labeled #3.
8. Using three (3) 3" Torx head screws, attach the edge of the wall #2 corner stud to the wall #3 corner stud.

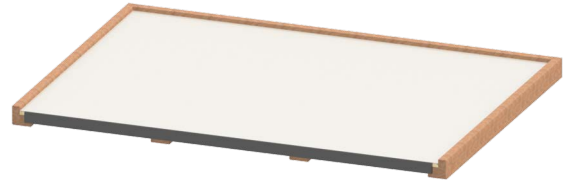

Figure 3. Laying the Floor Panel

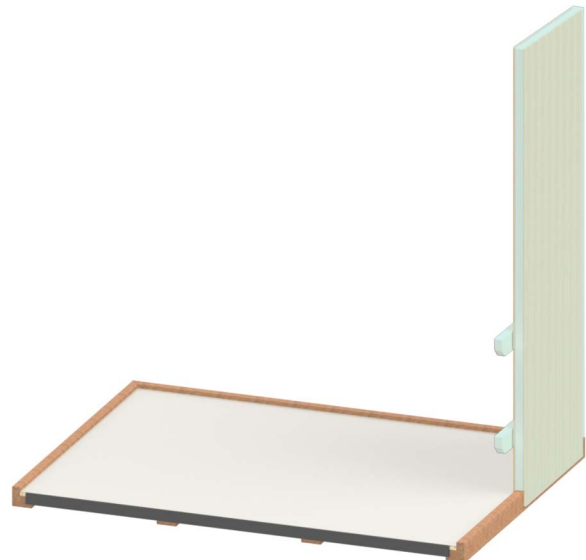

Figure 4. Installing #2 Wall Section



Figure 5. Installing #3 Wall Section

INSTALLING BACK-LEFT WALL SECTION

9. Place wall #4 onto the base rail section labeled #4.
10. Fit together the edge tongue and grooves of wall #4 with the tongue and grooves of wall #3.
11. Using one (1) 3" Torx head screw, toenail the top corner of wall #4 to wall #3.

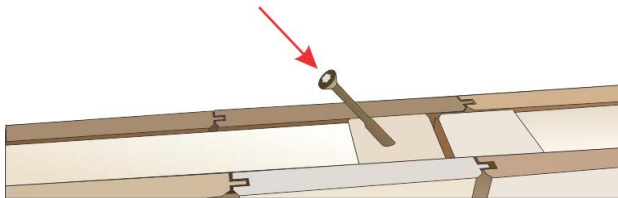

Figure 6. Toe-Nailing Example

INSTALLING LEFT-BACK WALL SECTION

12. Place wall #5 wall onto the base rail section labeled #5.
13. Align and fit the corner of wall #5 with the corner of wall #4.
14. Using three (3) 3" Torx head screws, attach the edge of wall #5 corner stud to the edge of wall #4 corner stud.
15. Using one (1) 3" Torx head screws, attach wall #5 to the base rail.



Figure 7. Pockets for Attaching Walls to Base Rail



Figure 8. Installing Back-Left Wall Section



Figure 9. Installing Left-Back Wall Section

INSTALLING LEFT-FRONT WALL SECTION

16. Place wall #6 onto the base rail labeled #6.
17. Fit together the edge tongue and grooves of wall #6 with tongue and grooves of wall #5.
18. Using one (1) 3" Torx head screw, toe-nail the top corner of wall #6 to wall #5.



Figure 10. Installing Left-Front Wall Section

INSTALLING FRONT WALL FRAME ASSEMBLY

There are two lines of thought regarding when to attach the frame to the left wall. Either **(a)** when the frame is initially placed, or **(b)** after the right wall is installed. Either case is suitable and at the discretion of the installer.

19. Orient the front wall frame assembly with the door opening outwards from the sauna.
20. Lift the front wall frame assembly and place the sill onto the front edge of the floor.
21. Abut the left edge of the front wall frame to the front corner of the left wall, behind edge of front trim.
 - a. To attach wall #6 to the frame at this time, use the following sub-steps, otherwise, skip to Step 22.
 - b. Using three (3) 3" Torx head screws, attach left edge of front wall frame to wall #6.



Figure 11. Installing Front Wall Frame Assembly

INSTALLING WALL #1

22. Hold the front wall frame assembly in place while wall #1 is installed.
23. Place wall #1 onto the base rail labeled #1.
24. Fit together the edge tongue and grooves of wall #1 with the tongue and grooves of wall #2.
25. Abut the right edge of the front wall frame to the front corner of the right wall, behind edge of front trim.
26. Using one (1) 3" Torx head screw, toe-nail the top corner of wall #1 to wall #2.
27. Using one (1) 3" Torx screw, attach wall #1 to the base rail.
28. Using three (3) 3" Torx head screws, attach the right edge of front wall frame to wall #1.
29. Unless completed earlier, now perform the sub-steps located in Step 21.
30. Using one (1) 3" Torx head screw, attach wall #4 to the base rail.
31. Using one (1) 3" Torx head screw, attach wall #2 to the base rail and one (1) screw to attach wall #3 to the base rail.
32. Through the vent opening, use one (1) 3" Torx head screw to attach wall #6 to the base rail.
33. Install covers over the pocket openings and nail the covers in place.
34. Install vent cover.

INSTALLING DOOR HANDLE

35. Arrange the door handles and hardware as shown in Figure 13. Screws and cap are installed from inside the door.
36. Place the door handles on either side of the glass door, aligning with the holes in the glass.
37. Install the spacers into the holes in the glass.
38. Using the two (2) M4 x 100mm Phillips head screws included in the kit, attach the door handles to the glass door.

NOTE: Install screws by hand with a screw driver
DO NOT USE a power tool.

39. Install the caps into the ends of the handle screw holes.



Figure 12. Installing Right-Front Wall Section

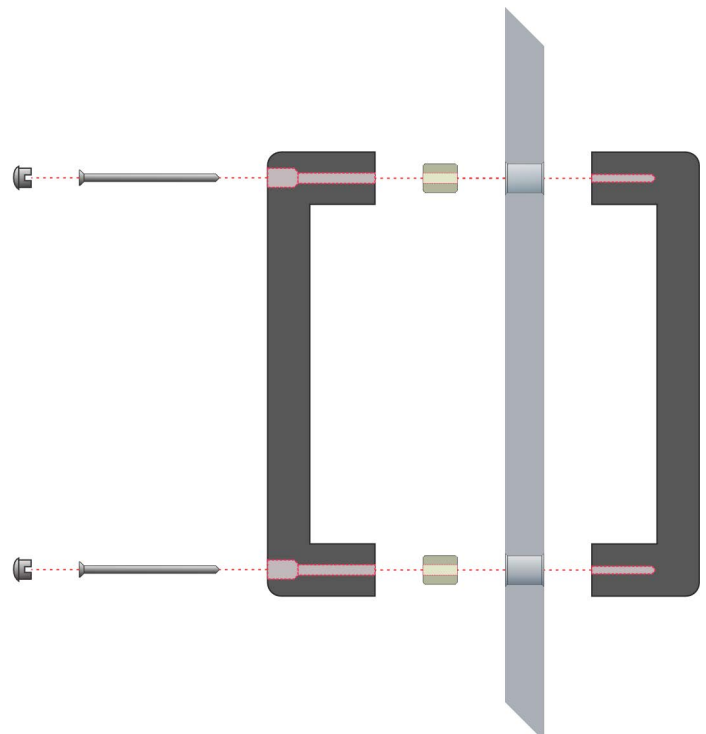

Figure 13. Installing Door Handle

INSTALLING CABLE TRACK

40. Remove the backing from the double-sided adhesive tape of the cable track and apply to the bottom edge of the **Back** wall.
41. Remove the backing from the double-sided adhesive tape on the cable track and apply to the bottom edge of the **Left** wall.

INSTALLING CONTACTOR (CB) BOX

42. Remove the cover of the CB Box to gain access to the four (4) mounting holes located in the back of the box.
43. Set the hardware and cover aside in a safe location.
44. Position the CB Box onto the wooden “L” pencil trim located inside of the back-left (#4) wall.
45. Using the four (4) 3/16” x 3/4” screws supplied with the kit, attach the CB Box to the wall.

ROUTING CABLES

46. If this is a Lulea 4 sauna room, route the lighting cable from the right corner (#2 wall) into the back wall cable track and over to the back left corner.

NOTE: The Lulea 3 does not include this cable.

47. Route the lighting cable from the back left corner (#3 wall) into the back wall cable track.
48. Route the control, lighting, and temperature sensor cables from the front left wall into the left wall cable track to the back left corner.

CONNECTING CABLES

Electrical installation must be made by a licensed electrician in accordance with the National Electric Code and local regulations.

49. Route the low voltage cables through a bottom opening located on the low voltage side of the CB box.
 - a. Included in the accessory box, there are two (2) pigtail (5-pin connector to female RJ45) cables and if this is for a Lulea 4, one (1) splitter (Male RJ45 to two (2) Female RJ45s) cable.
 - b. Connect the pigtail cables to the Light1 and Light2 connectors.
 - c. For the Lulea 4, connect the splitter to the Light1 pigtail.
50. Route the incoming power cable through a bottom opening located on the high voltage side of the CB box.
51. For additional electrical information, see “SECTION 7. ELECTRICAL HOOK-UP” on page 29.



Figure 14. Installing Cable Track and CB Box

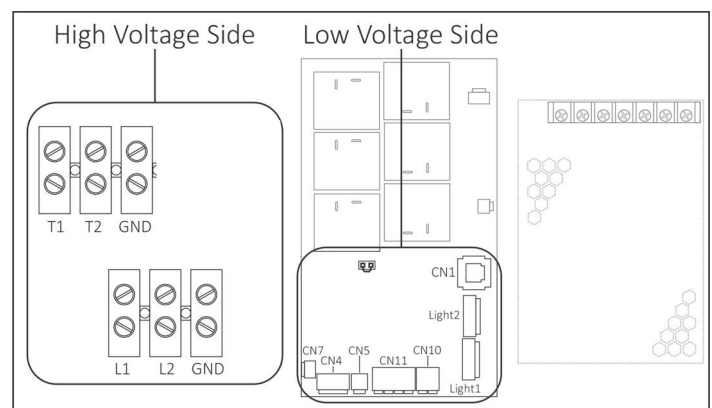

Figure 15. CB Box Internal View

INSTALLING the ROOF

52. Apply 1" wide weather stripping across the top edge of all four walls.



HEAVY OBJECT: A minimum of two people are required to lift the roof sections into place.

53. Carefully lift and place the rear roof/ceiling onto the rear left, right, and back wall sections of the sauna room (A).
54. Dress the cable from the top of the forward left wall out and over the edge of the wall (B).
55. Place a foam or wood block on top of the left wall to protect the cables (C).
56. Carefully lift and place the front roof/ceiling onto the forward left block and right wall section.
57. Connect an in-line RJ45 connector to the cable (D).
58. Connect the lighting cable from the front roof to the in-line RJ45 connector.
59. Push the slack of the connected cables into the hole of the front roof/ceiling cavity.
60. Remove the block and abut the rear edge of the front roof/ceiling section to the front edge of the rear roof/ceiling section.
61. Join together the tongue and groove planks where the Front and Rear ceilings meet, while ensuring where the sides of the front and rear roof sections meet are flush.
62. Using two (2) 3" Torx screws, toenail the left rear roof side to the left front roof side (E).
63. Using two (2) 3" Torx screws, toenail the right rear roof side to the right front roof side (F).
64. Measure the front soffit reveal from the front edge of the #1 and #6 panels. The amount should be ~14" (G).
65. Square the front left and right walls near the edge trim for equal soffit reveal, ~8" (H).
66. Square the back left and right corners for equal soffit reveal, ~8" (J).
67. Using four (4) 5" Torx head screws, attach the roof down to the four (4) wall corners (K).
68. Press a straight edge against the adjoining walls near the top to align and straighten the walls (M).
69. On either side of the butt joint between walls, use a 5" Torx head screw to attach each wall to the roof (N).
70. Repeat the above two (2) steps for the left, right and back walls.



Figure 16. Applying Weather Stripping

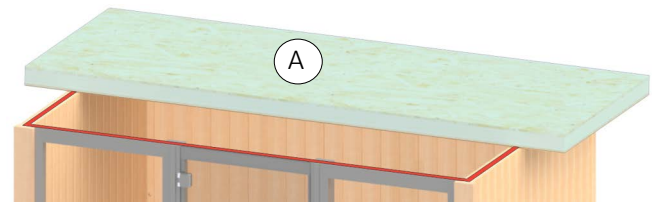

Figure 17. Placing the Rear Roof

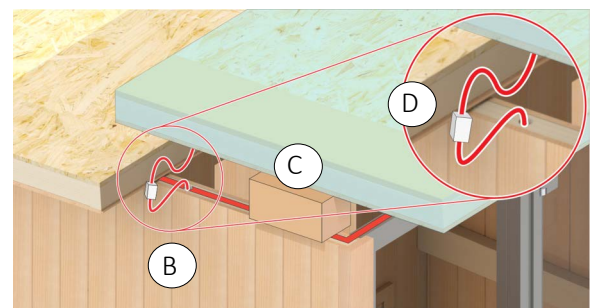

Figure 18. Placing the Front Roof and Cable Connection

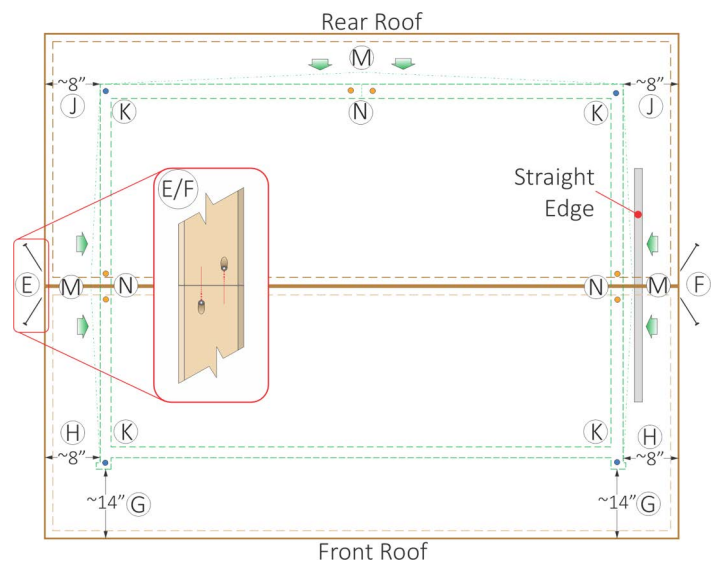

Figure 19.

ALIGNING front wall frame ASSEMBLY

As installation nears completion, critical alignments are necessary before interior trim and side panes of glass are installed.

71. Using a bubble level check the door frame for plumb, squareness, inside, outside, left, and right orientations.
72. While holding the front wall frame assembly steady in place, test the operation of the door to ensure it opens, and closes easily and securely.
73. With the door closed, check all edges of the door glass to ensure even pressure is applied on all seals.
 - If the seal is uneven, the jamb is twisted (either the header jamb or sill is in/out in relation to the other).
 - Using a bubble level, re-verify all edges for plumb and are square to each other.
74. Using one (1) 4" screws, attach the right window head jamb to the ceiling.
75. Using one (1) 2-1/2" screws, attach the right window sill to the floor.
76. Using one (1) 4" screws, attach the left window head jamb to the ceiling.
77. Using one (1) 2-1/2" screws, attach the left window sill to the floor.



Figure 20. Aligning front wall frame Assembly

INSTALLING WOOD FASCIA



CAUTION: Ensure that you have assistance to hold the fascia boards in place while nailing.

78. Using 2" 16 gage or equivalent finish nails or wood screws, Attach the fascia to the **Right** edge of the roof.
79. Using 2" 16 gage or equivalent finish nails or wood screws, Attach the fascia to the **Left** edge of the roof.



Figure 21. Installing Left and Right Side Wood Fascia

80. Using 2" 16 gage or equivalent finish nails or wood screws, Attach the fascia to the **Back** edge of the roof.
81. Using 2" 16 gage or equivalent finish nails or wood screws, Attach the fascia to the **Front** edge of the roof.

NOTE: Metal fascia and roofing is installed as a later part of this procedure. See "SECTION 6. INSTALLING METAL FASCIA and ROOFING" on page 22.

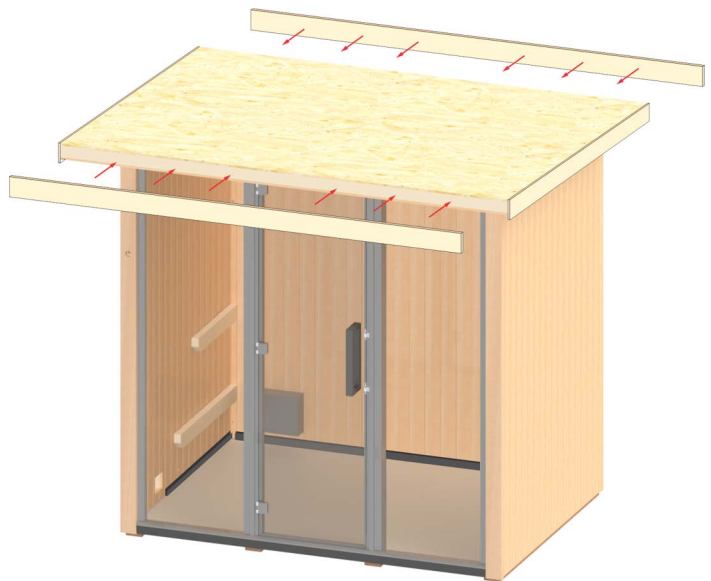

Figure 22. Installing Front and Back Wood Fascia

INSTALLING CORNER T&G PLANKS and CORNER TRIM

82. From the **Right**-rear corner, install the associated plank that fits into the exterior T & G and nail into place.
83. Install the right corner trim over the right-rear corner and nail into place
84. From the **Left** -rear corner, install the associated plank that fits into the exterior T & G and nail into place.
85. Install the left corner trim over the left-rear corner and nail into place.

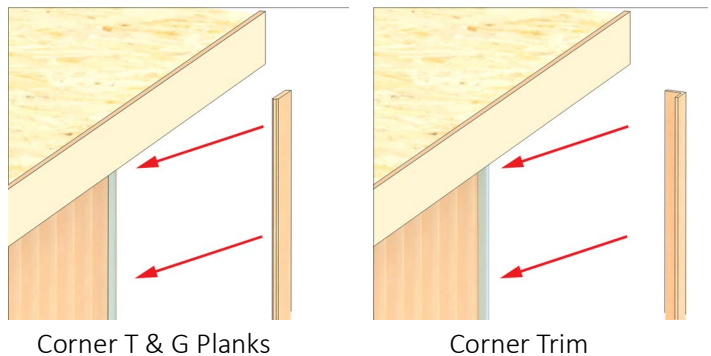

Figure 23. Installing Planks and Trim

INSTALLING SOFFIT TRIM

86. Using 1 ½" 18 gage finish nails or equivalent, attach the **Back** soffit trim beneath where the soffit meets the back fascia.
87. Using 1 ½" 18 gage finish nails or equivalent, attach the **Right** soffit trim beneath where the soffit meets the right fascia.
88. Using 1 ½" 18 gage finish nails or equivalent, attach the **Left** soffit trim beneath where the soffit meets the left fascia.
89. Using 1 ½" 18 gage finish nails or equivalent, attach the **Front** soffit trim beneath where the soffit meets the front fascia.



Figure 24. Installing Soffit Trim

INSTALLING EXTERIOR COVE TRIM

90. Using 1 ½" 18 gage finish nails or equivalent, attach the **Right** exterior cove trim beneath where the #1 and #2 walls meet the soffit.
91. Using 1 ½" 18 gage finish nails or equivalent, attach the **Left** exterior cove trim beneath where the #5 and #6 walls meet the soffit.
92. Using 1 ½" 18 gage finish nails or equivalent, attach the **Back** exterior cove trim beneath where the #3 and #4 walls meet the soffit.



Figure 25. Installing Exterior Cove Trim

INSTALLING INTERIOR COVE TRIM

93. Using 1 ½" 18 gage finish nails or equivalent, attach the **Back** interior cove trim beneath where the #3 and #4 walls meet the ceiling.
94. Using 1 ½" 18 gage finish nails or equivalent, attach the **Right** interior cove trim beneath where the #1 and #2 walls meet the ceiling.
95. Using 1 ½" 18 gage finish nails or equivalent, attach the **Left** interior cove trim beneath where the #5 and #6 walls meet the ceiling.



Figure 26. Installing Interior Cove Trim

INSTALLING LOWER BENCH

96. Carefully bring the (narrow width) lower bench into the sauna room.
97. Place each end of the lower bench onto the lower wall braces.
98. Slide the lower bench towards the back wall.

NOTE: The top of the CB box may stop the bench from reaching the back wall.



Figure 27. Installing Lower Bench

INSTALLING UPPER BENCH

99. Carefully bring the (wide) upper bench into the sauna room.
100. Place each end of the upper bench onto the upper wall braces.
101. Slide the upper bench all the way to the back wall.

NOTE: DO NOT secure the upper bench until **AFTER** the glass side panes are installed.



Figure 28. Installing Upper Bench

INSTALLING ARMREST AND RETURN BENCH

NOTE: These steps apply only to the Lulea 4 sauna room.
For the 3-person sauna room, proceed to instructions on *Installing Backrests*.

102. Bring the armrest into the room and position it in the right-front corner (A).
103. Bring the return bench into the room (B). Rest the front edge onto the armrest brace and position the rear edge to the front-right edge of the upper bench.
 - The return bench also rests on a support brace mounted to the right wall.
104. Align the seams between the bench planks of the upper bench and return bench (C).

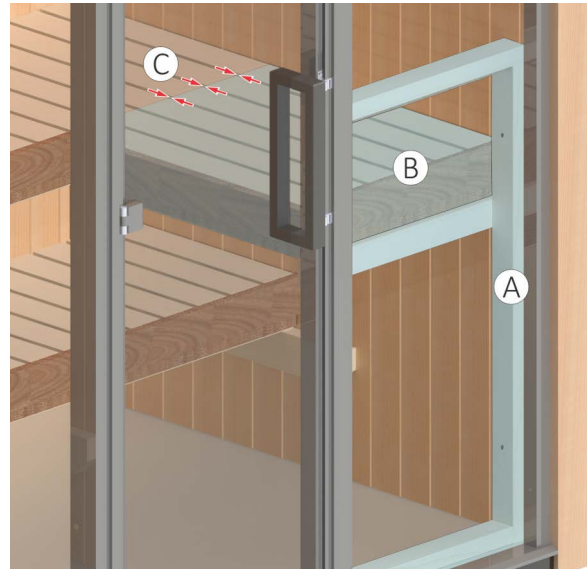

Figure 29. Installing Armrest and Return Bench

105. From beneath the return bench, Temporarily use two (2) 2" Torx head screws (D) to hold the rear edge of the return bench to the front right edge of the upper bench.
106. Then drill two (2) 3/8" holes through the rear edge of the return bench and front right edge of the upper bench.
107. Insert two (2) 5" x 3/8" carriage bolts through the holes and permanently attach the upper bench and return bench together using 3/8" hex nuts and washers.

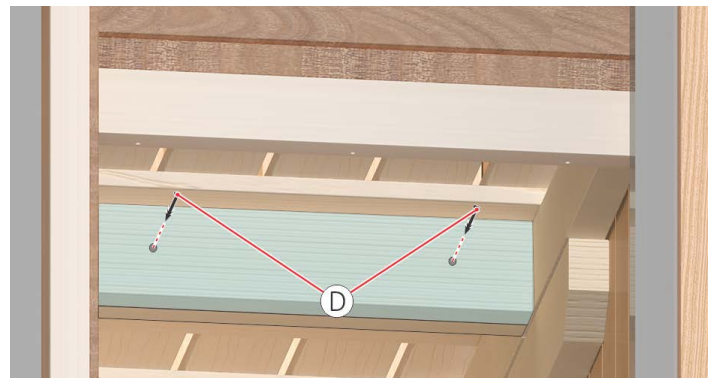

Figure 30. Attaching the Return Bench

108. Equalize the spacing between the walls and upper bench on the left, back, and right edges (E).
109. Press the armrest up to the front edge of the return bench (F) and also press the right edge of the armrest to the right wall.

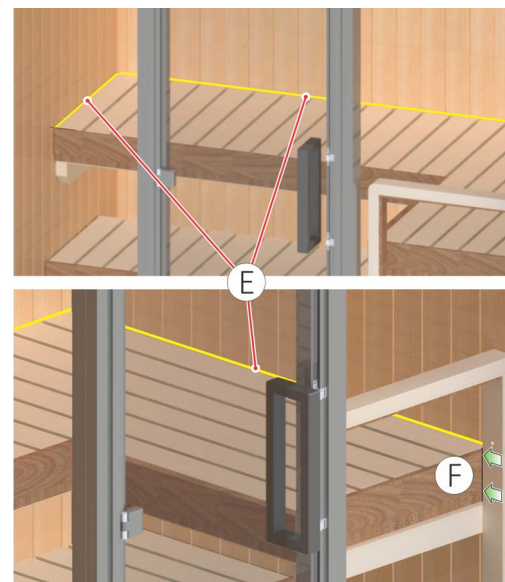

Figure 31. Equalizing Bench-to-Wall Spacing

110. Using two (2) 3" Torx head screws (**G**), attach the armrest frame to the right wall.

NOTE: DO NOT use 4" long screws when attaching the armrest frame to the wall. Verify length of screws before attaching.

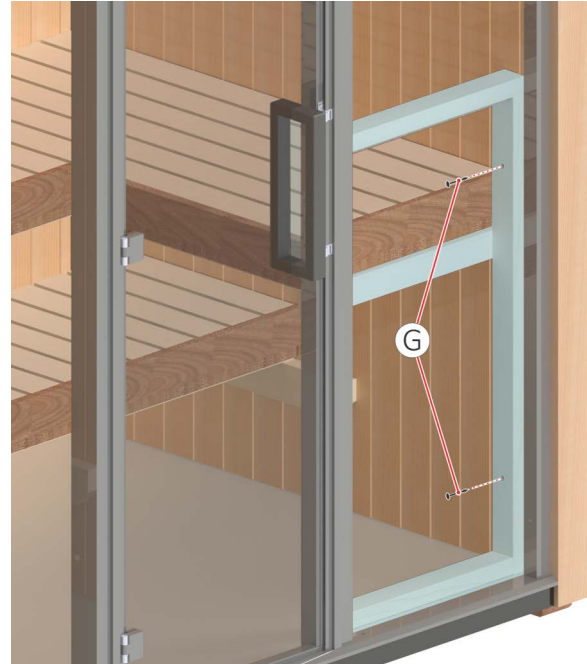

Figure 32. Attaching the Armrest to Wall

111. Using two (2) 4" Torx head screws (**H**), attach the bottom of the armrest brace to the bottom edge of the return bench.

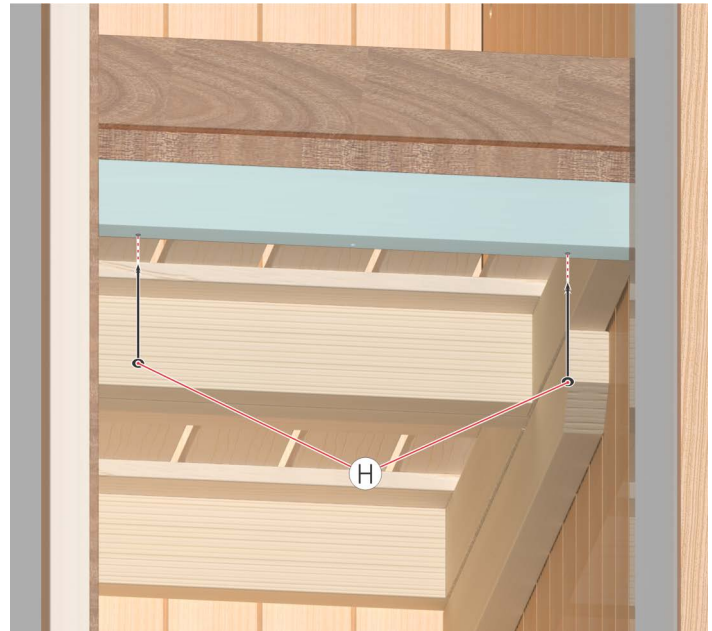

Figure 33. Attaching Armrest to Return Bench

INSTALLING BACKRESTS

112. Connect the lighting cable from the rear backrest to the corresponding mating cable from the upper back-left corner.
113. Mate the upper rear backrest with the French cleats located on the upper back wall (A).
114. For the Lulea 4 sauna, connect the lighting cable from the right backrest to the corresponding mating cable from the upper right-back corner.
115. If this is a Lulea 4 sauna, mate the upper right backrest with the French cleats located on the upper right wall (B).
116. Neaten up the cables and tuck into the cable chases behind the backrests.



Figure 34. Installing Backrests

MOUNTING THE HEATER

The heater will mount on the (#6) front-left wall.

117. Prepare the heater for installation. See the appropriate sauna heater installation and operating instructions manual.
118. Using the measurements provided in Figure 35, verify the position of the pre-drilled mounting holes for the heater.
119. Install the four (4) lag bolts (included with the heater) into the wall for mounting the heater.
120. Leave about 1/4" of the screw shaft exposed for the heater hangers to rest on.
121. Hang the heater onto the four (4) bolts, then tighten the bolts to the wall.

Instructions for electrically connecting the heater are provided later in "SECTION 7. ELECTRICAL HOOK-UP" on page 29.

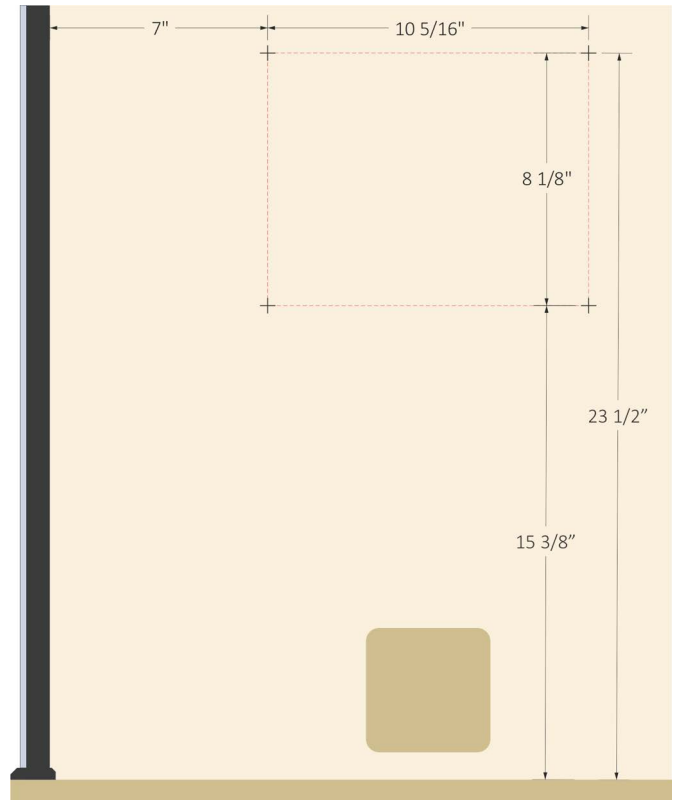

Figure 35. Heater Mounting Measurements

INSTALLING GLASS SIDE PANES

The left glass pane includes the Tylö™ logo located to the top exterior of the glass. Each glass pane also includes the words: "Tempered Glass" etched at the bottom.

122. Using glass lifting suction cups, carefully lift the glass pane for the right side and place it onto the exterior of the front wall frame.
123. Install the six (6) plastic retainers (**A**) into the holes in the glass pane.
124. Center the glass in the front wall frame to provide equal spacing on either side.
125. Using six (6) 1" cabinet screws (**B**), attach the right side pane to the frame.
126. Snap on the six (6) plastic caps (**C**) over the retainers.
127. Repeat the above steps for the left glass pane.
128. Using four (4) 3" Torx head screws, attach the upper bench frame to the back and side walls.

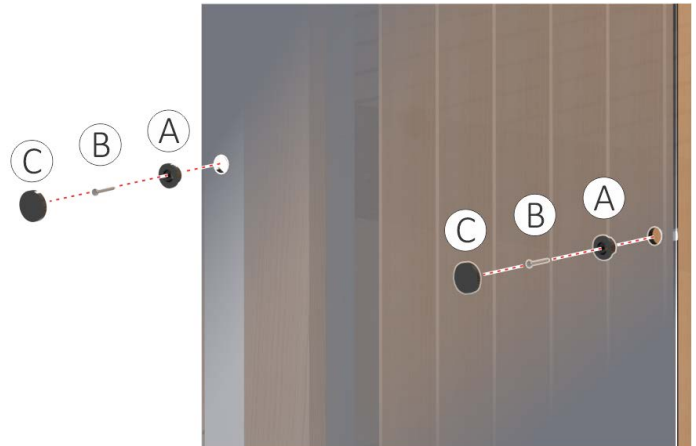

Figure 36. Installing Glass Panes

SECTION 6. INSTALLING METAL FASCIA and ROOFING

Use the following instructions for preparing and installing metal fascia and roofing onto the outdoor sauna room.

ROOFING MATERIALS

Item #	Description	QTY
1	Felt, Roofing, #15, Plain	80 Sq Ft
2	Roof, Closer, Inside, Pro-Rib, 1" x 3", Strip	3 pcs
3	Roof, Closer, Outside, Pro-Rib, 1" x 3" Strip	3 pcs
4	Roof, Drip Edge, 3" x 2-1/4" x 10', Midnight Black	1 pc
5	Roof, Side Fascia, 4-1/8" x 5-1/4" x 10', Midnight Black	2 pcs
6	Roof, Ridge Cap, 5-3/8" x 5-14" x 10', Midnight Black	1 pc
7	Roof, Rear, Lower Fascia, 3/4" x 3" x 10', Midnight Black	1 pc
8	Roof, MTL, Pro-Rib, 36" x 7', Midnight Black	3 pcs
9	Screw, Sheet metal, #8 x 1-1/4" Star drive, T10, Midnight Black, Pan head	12 pcs
10	Screw, Sheet metal, #10 x 2-1/4" Hex Head, Midnight Black, W/W	40 pcs

NOTE: Spare screws are included with the hardware.

TOOLS REQUIRED

- Step Ladder
- Tape Measure, Straight Edge/Square
- 1/8" metal-cutting drill bit.
- Drill, 1/4" Hex Head Magnetic Socket, and T10 Torx Head Drive Bit
- Tin Snips
- Pencil, String/Chalk Line
- Stapler and Roofing Staples

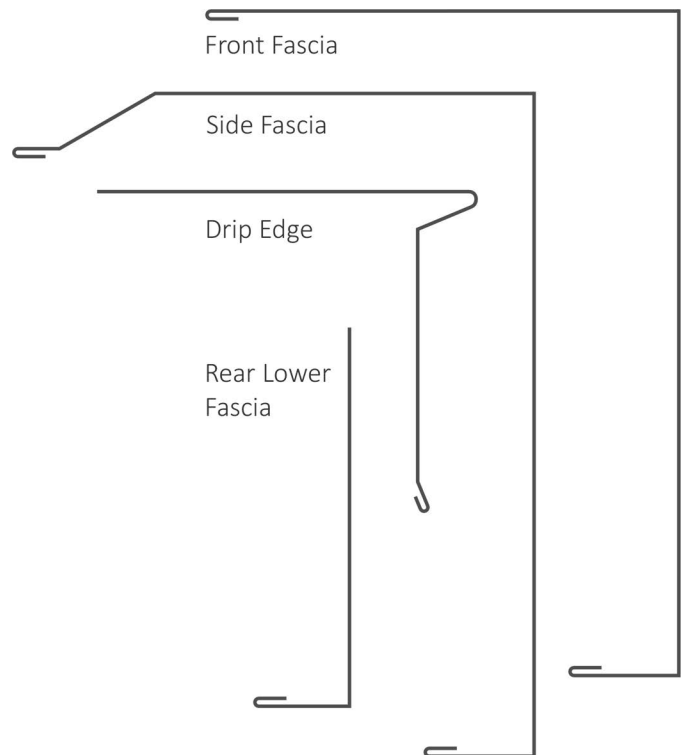
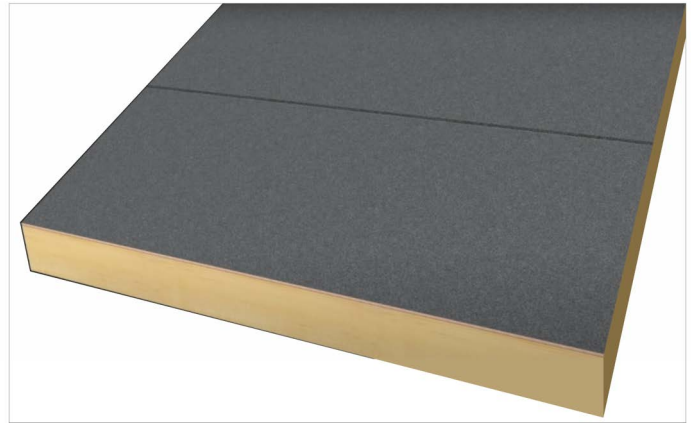

Figure 37. Metal Fascia Profiles

APPLYING WEATHER BARRIER

1. Using a stapler and roofing staples, apply weather barrier onto the wood decking, overlapping the ends onto the front, sides, and back edge fascia.

**Figure 38. Applying Weather Barrier****APPLYING DRIP EDGE and LOWER REAR FASCIA**

2. Pre-fit the drip edge flashing **over** the weather barrier and back edge of the wood decking.
3. Using a tin snip, cut and shape/bend the ends of the drip edge flashing to overlap the corners of the wood fascia.
4. From the top surface of the drip edge, use #8 x 1-1/4" T10 pan head screws (or 1-1/4" galvanized nails), spaced accordingly, to attach the flashing to the wood decking.
 - Ensure correct compression of the neoprene washer on each screw. (With the edge of neoprene appearing marginally proud from the edge of the steel washer).

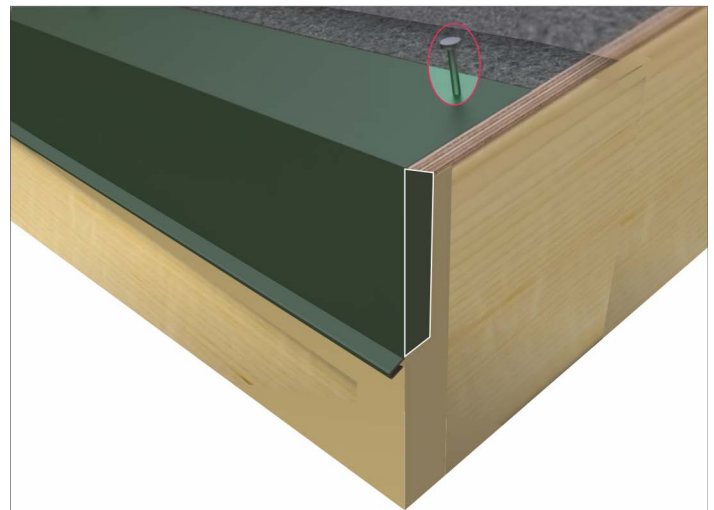
**Figure 39. Applying Drip Edge**

5. Pre-fit the lower rear fascia beneath the drip edge flashing.
6. Using a tin snip, cut and shape/bend the ends of the lower rear fascia to overlap the corners of wood fascia and to fit beneath the edges of the drip edge flashing.
7. Slide the top edge of the lower rear fascia up under the drip edge flashing and press up to overlap the bottom edge of the wood fascia.
8. Using #8 x 1-1/4" T10 pan head screws, spaced accordingly, attach the bottom overlapped edge of the lower rear fascia to the bottom edge of the wood fascia.
9. Using #8 x 1-1/4" T10 pan head screws, spaced accordingly, attach the dropped side of the drip edge and lower rear fascia (the portion tucked beneath the drip edge) to the back wood fascia.

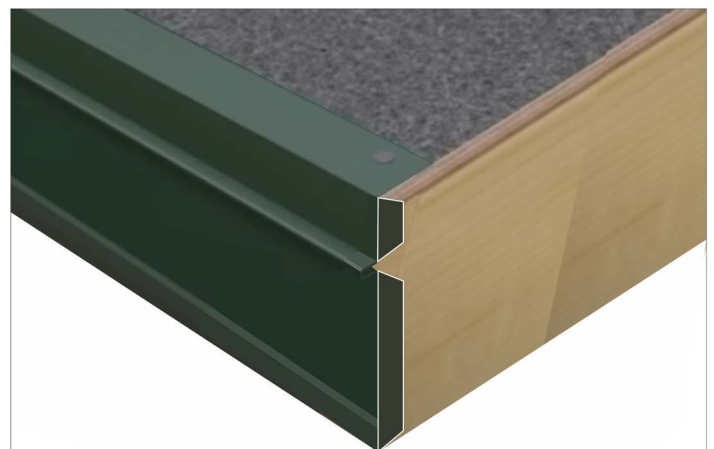
**Figure 40. Applying Lower Rear Fascia**

APPLYING SHEET METAL ROOFING

10. For the geographic location of where this sauna is installed, lay the metal roof sheets in the direction **TOWARDS** the prevailing winds.
 - Meaning, begin from the opposite end of the roof, moving towards the direction the wind predominately blows **from** most of the year.
 - Orient the “trailing (overlap) edge” of the sheet metal in the direction furthest away from the wind.
11. Plan for laying the sheet metal such that the trailing (overlap) edge of each successive panel will overlap the leading edge (purlin bearer leg) of each previous panel.
12. Using a straight edge/square, draw a reference chalk line 1/4” from the edge of the wood deck along the starting (gable) edge of the roof.
13. Remove the paper backing from the self-adhesive tape and apply a strip of polyethylene closure onto the top edge of the drip edge fascia.
14. When laying the first sheet, align the side edge with the reference chalk line.
 - The bottom (back) edge of the roofing sheet should overhang past the back drip edge flashing by 1-inch.
 - The front (top) edge of the roofing sheet will be covered later by the front fascia.

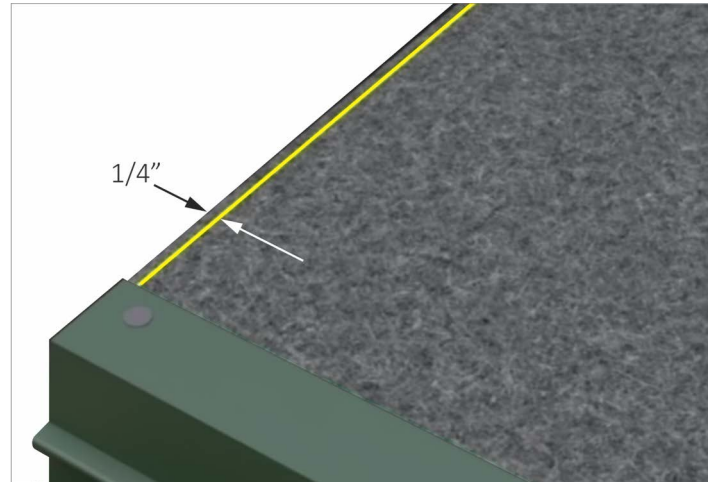
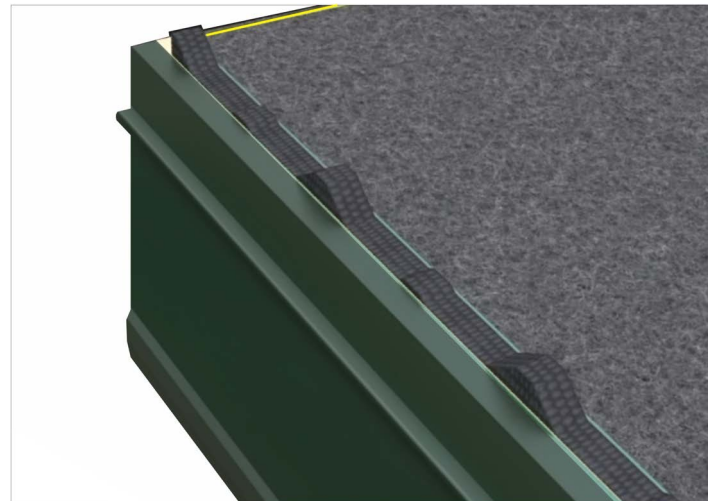
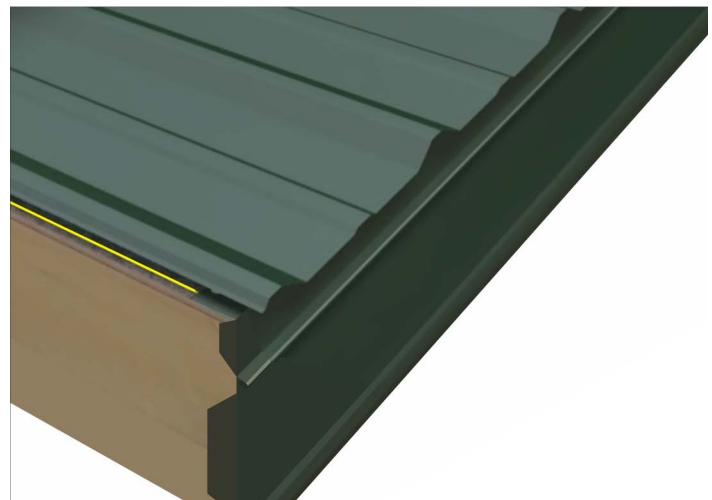
**Figure 41. Drawing a Chalk Line****Figure 42. Applying Polyethylene Closure****Figure 43. Aligning Edge with Chalk Line**

15. Using appropriately sized milled point screws, spaced accordingly, attach the metal sheet from the valley (not the crown) onto the wood decking.

- **TIP:** Using an 1/8" metal drill bit, pre-drill the holes into the steel only.
- Ensure correct compression of the neoprene washer on each screw. (With the edge of neoprene appearing marginally proud from the edge of the steel washer).

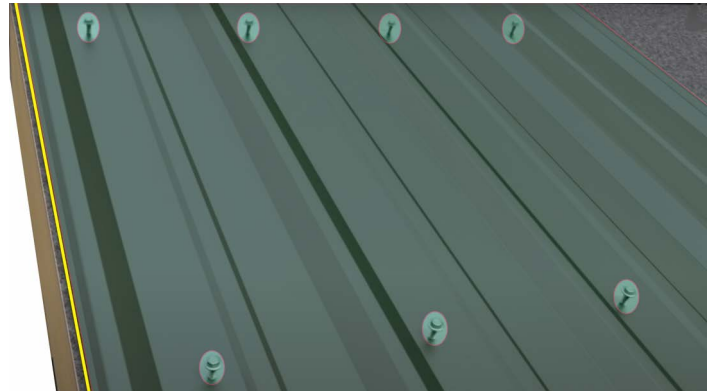

Figure 44. Attaching the Metal Roofing

16. Carefully align the bottom edge of the next metal sheet with the bottom edge of the previously attached metal sheet.

17. For the next metal sheet, lay the crown of the trailing (overlap) edge onto the leading edge (purlin bearer leg) of the previously attached metal sheet.

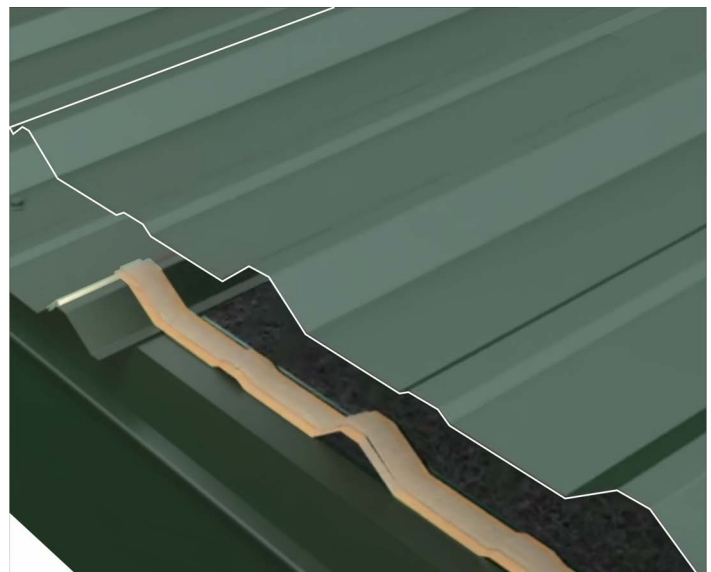

Figure 45. Aligning and Laying Second Sheet

18. Using appropriately sized stitch screws, spaced accordingly along the overlapping crown, attach the new sheet to the previous sheet.

- Ensure correct compression of the neoprene washer on each screw. (With the edge of neoprene appearing marginally proud from the edge of the steel washer).



Figure 46. Attaching Overlapped Crown

- Repeat Step 15 through Step 18 for each successive roofing panel.

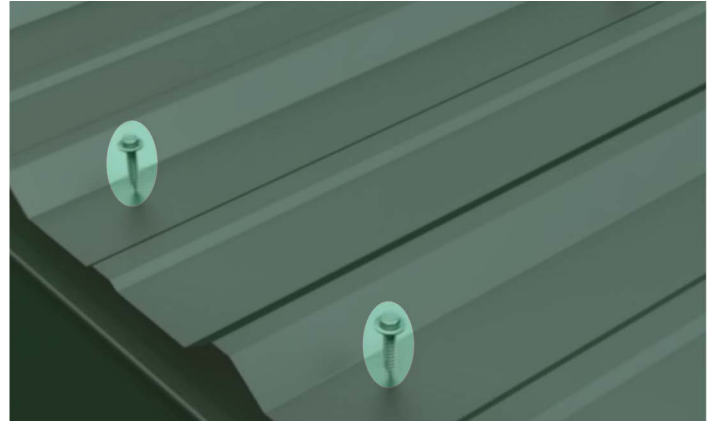

Figure 47. Attaching Roof Panel to Wood Decking

INSTALLING SIDE FASCIA

- Pre-fit the metal side fascia over each side of the roof.

NOTE: The three (3) steps below are optional. The bottom (back) end of the side fascia can be folded and boxed as shown, or skip these three (3) steps and leave the sheet metal alone with the standard factory edge.

- Cut (illustrated as red lines) and remove the waste pieces (illustrated in white coloration).
- Fold the ends of the side Fascia (Illustrated as white lines) to cover the top and bottom ends of the metal roof sheets.

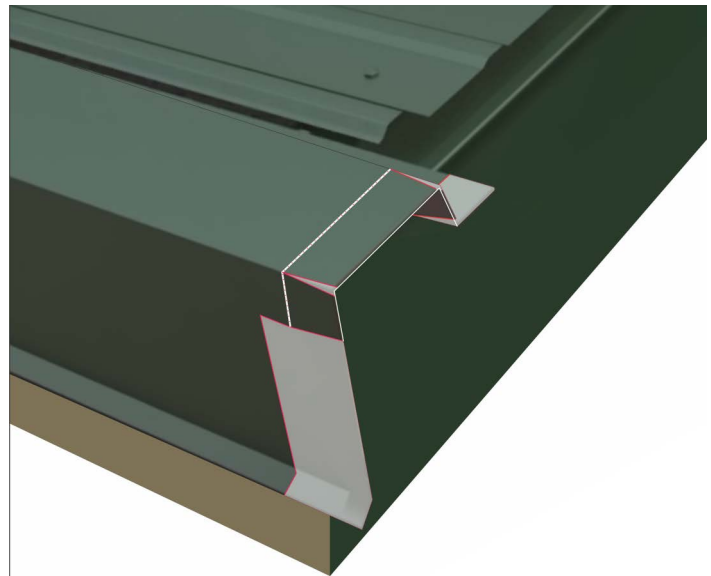

Figure 48. Cuts, Waste Pieces, and Folds Marked

- Secure the fold with a rivet that will overlap the roof crown.

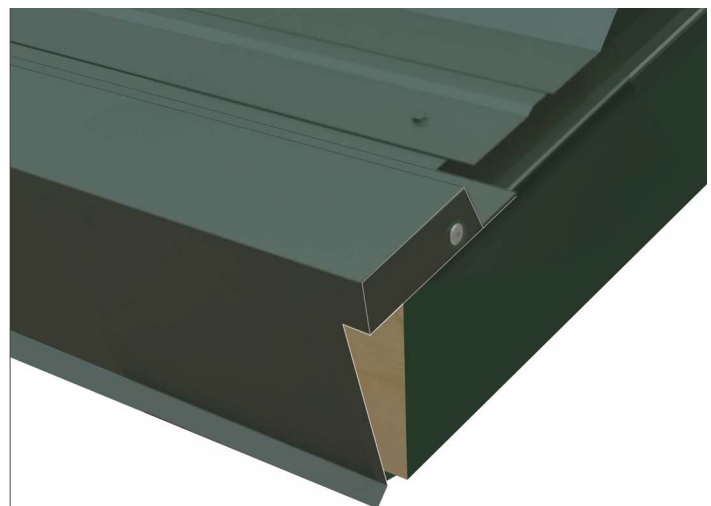

Figure 49. Ends Folded and Riveted

24. With the side fascia right-side up, carefully align and apply the side fascia down over the roof edge crown while simultaneously pressing the side of the metal fascia against the wood fascia.
25. Using appropriate sized milled point screws, spaced accordingly, attach the lapped edge at the top of the side fascia down onto the metal roof sheet.
 - Ensure correct compression of the neoprene washer on each screw. (With the edge of neoprene appearing marginally proud from the edge of the steel washer).
26. Using #8 x 1-1/4" T10 pan head screws, spaced accordingly, attach the overhanging portion of the metal side fascia to the wood fascia.

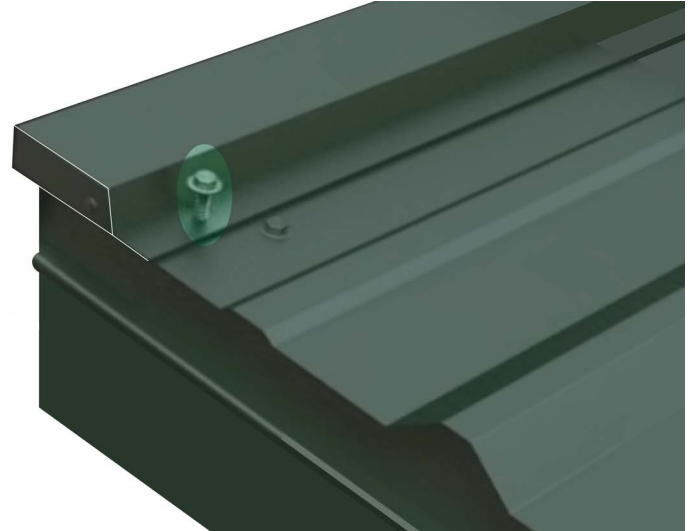

Figure 50. Attaching the Side Fascia

INSTALLING FRONT EDGE CAP

27. Remove the paper backing from the self-adhesive and apply a strip of polyethylene closure approximately 2" from the front edge.

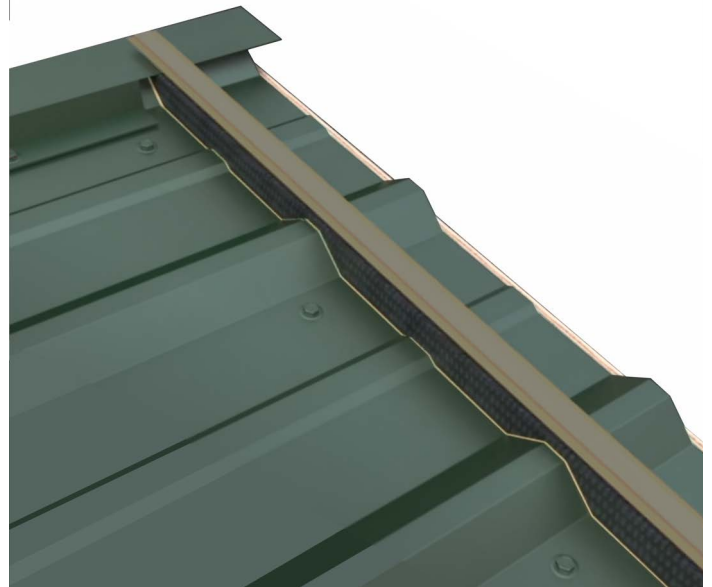

Figure 51. Applying Polyethylene Closure and Tape

28. Measure across the front fascia and add 1 1/2" to the length.
29. Using a square for a straight line, mark the length to cut the front edge cap.
30. Using a tin snip, cut the front edge cap to length.
31. Use the following sub-steps to bend the metal on both ends of the front edge cap.
 - a. Using a square and a pencil, mark a fold line 3/4" (A) from each edge of the front edge cap.
 - b. Using a tin snip, cut away a 3/4" x 3/4" square (B) from the drip edge.
 - c. Cut away a 45° triangle (C) from the top corner.
 - d. Cut away a 22.5° triangle (D) from the front corner.
 - e. Using either a duckbill pliers or a jig using blocks of wood and clamps, fold the front edge over 90° (E).
 - f. Fold the top edge over 90° (F).

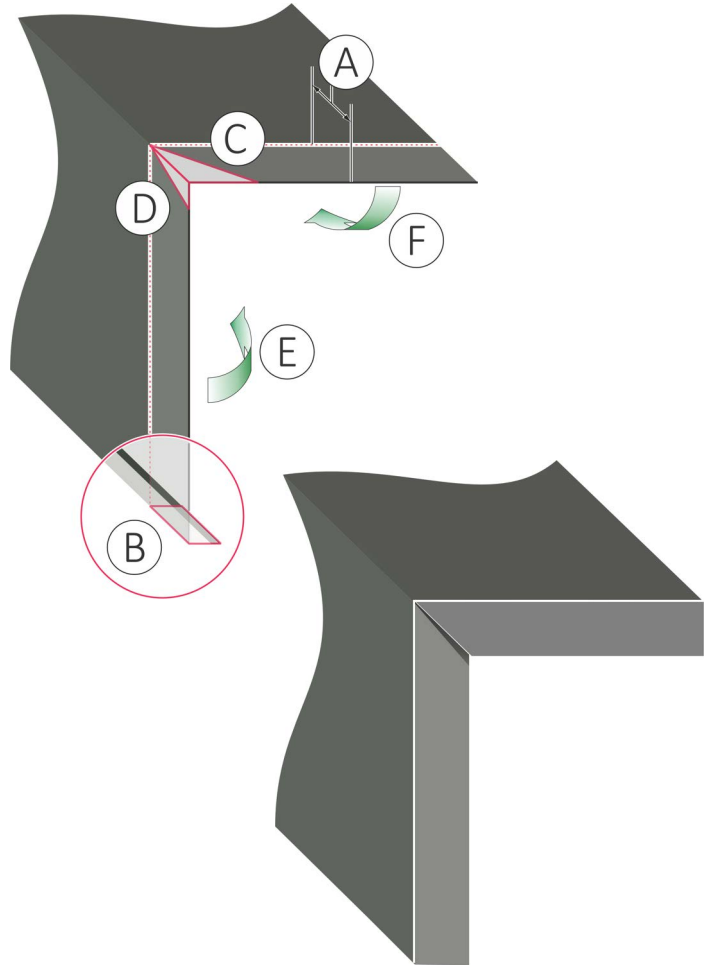

Figure 52. Folding Ends of Front Edge Cap

32. Apply the front edge cap down over the front edge of the roof while simultaneously pressing the front edge cap against the front wood fascia.
33. Using appropriately sized stitch screws, attach the front edge cap to the crowns of the roofing metal.
34. Using #8 x 1-1/4" T10 pan head screws, spaced accordingly, attach the dropped side of the front edge cap to the front wood fascia.
 - Ensure correct compression of the neoprene washer on each screw. (With the edge of neoprene appearing marginally proud from the edge of the steel washer).

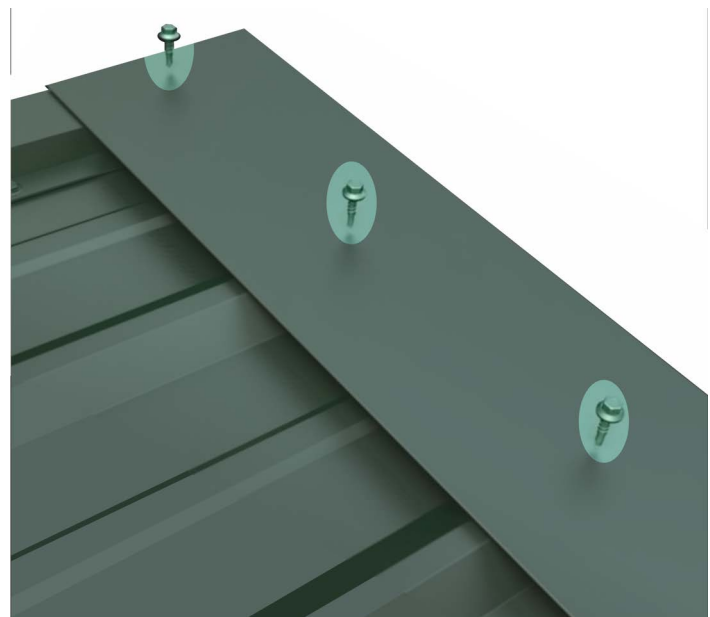

Figure 53. Attaching Front Edge Cap

SECTION 7. ELECTRICAL HOOK-UP

For reasons of safety, this manual does not include the complete steps for electrical installation of the heater.

Electrical installation must be made by a licensed electrician in accordance with the National Electric Code and local regulations.

NOTE: Refer to the corresponding heater *Installation and Operating Instructions* manual for electrical specifications, requirements, heater preparation, and electrical installation of the heater.

1. Route the heater power cable through an opening located on the bottom of the CB box, high voltage side.
2. Connect wires to the correct terminals. See “DIAGRAM 1. ELECTRICAL, 240VAC 1 PHASE”.

NOTE: The heater includes a small wire harness for the high limit control. This **MUST BE CONNECTED** for safe operation of the sauna.

3. Route the high limit control wires from the sauna heater through an available hole in the bottom of the CB Box, low voltage side.

NOTE: Maintain separation of high and low voltage wires.

4. Connect the wires to the high limit terminals (CN5) on the circuit board. See “DIAGRAM 1. ELECTRICAL, 240VAC 1 PHASE”.

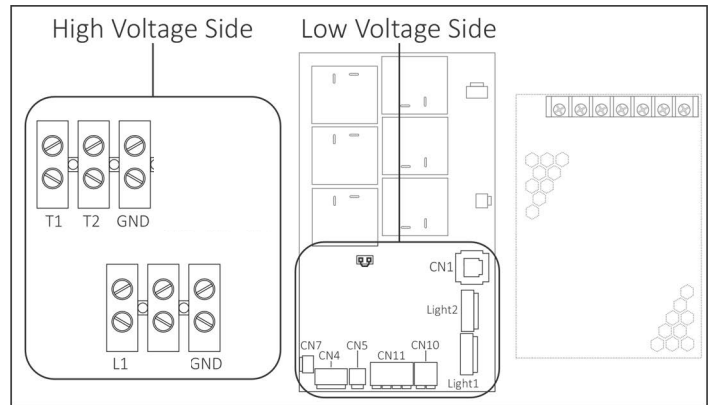

Figure 54. CB Box Interior

DIAGRAM 1. ELECTRICAL, 240VAC 1 PHASE

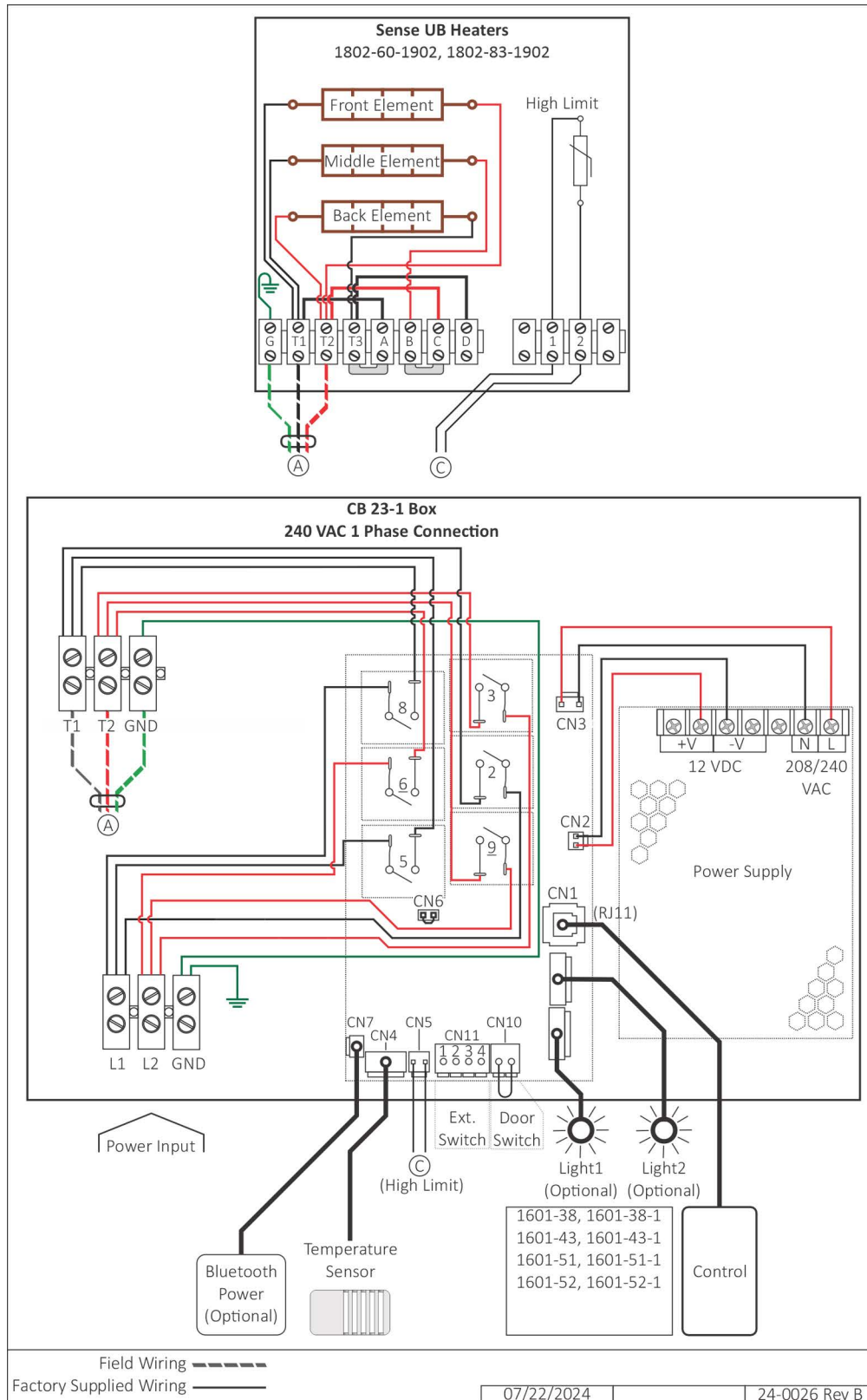
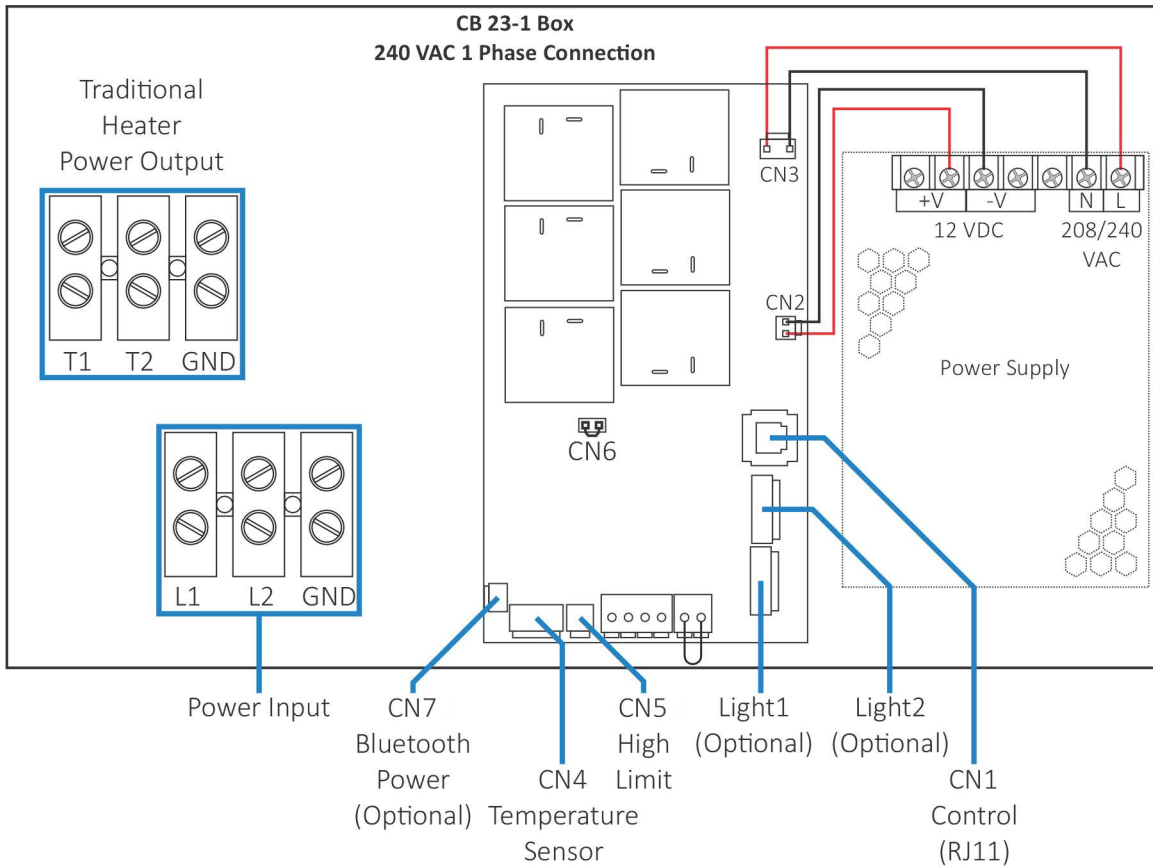

DIAGRAM 2. CB BOX INTERNAL VIEW



SECTION 8. CONTROL INSTALLATION

The Bliss control is weather resistant and water resistant, allowing it to mount either on the interior or exterior of the sauna room.

NOTE: If installing the control after applying paint/stain, allow the finish to completely cure before installing the control.

1. Locate the mounting hole provided in the front trim for the control.
2. Fish out a portion of the RJ11 control cable from the opening.

NOTE: Use the factory-supplied RJ11 control cable only. Do not staple through or otherwise damage the cable.

3. Using a clean, lint-free cloth, wipe all surfaces of the control to remove dust, debris and residue.
4. Orient the control with the UP arrow located on its back.
5. From the included parts, apply the double-sided tape to the back of the control.
 - Alternatively, apply silicone onto the back of the control.
6. Connect the RJ11 control cable to the female RJ11 jack located on the back of the control.
7. Wipe down the wall surface surrounding the cut hole to remove dust and debris.
8. Remove the protective backing from the double-sided tape.
9. Carefully square-up the control over the cut hole in the wall.
10. Press the control firmly in place, adhering the double-sided tape to the wall.

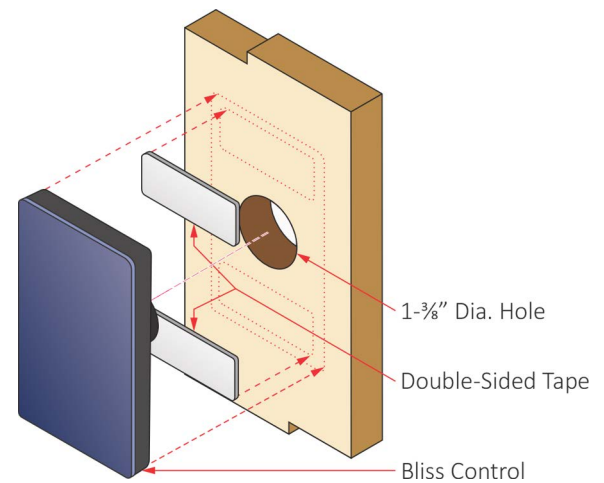

Figure 55. Mounting the Control

SECTION 9. OPERATING the CONTROL

The instructions provided here are for operating a traditional sauna heater. See **Bliss Operating Instructions** for further details on the control.

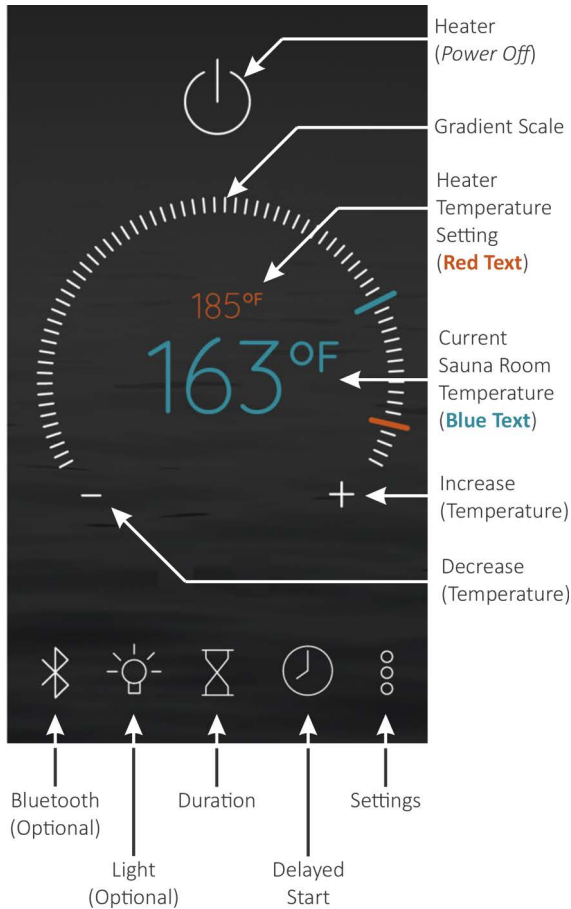

Figure 56. Control Icons

APPLYING POWER

Tap the **Power** icon once. The default settings for the temperature is 194°F, the bath time is 60 minutes. These settings are adjustable from 119° to 194°. Length of the sauna can be set from 0 to 60 minutes. The time delay before start can be up to 24 hours. Any changes are remembered by the heater for your next bath. Should the heater power be lost then restored, the settings will return to their default values.

GRADIENT SCALE

The scale is touch sensitive. Use the tip of your finger to scroll for increasing or decreasing a selected setting (i.e. temperature, duration, light color, light intensity, bluetooth audio volume).

HEATER TEMPERATURE SETTING

The temperature setting of the heater is displayed in small **red** colored text.

CURRENT SAUNA ROOM TEMPERATURE

The current sauna room temperature measured by the temperature sensor is displayed in large **blue** colored text.

INCREASE

Alternative to the gradient scale, tap the plus sign (+) icon to incrementally increase a selected setting.

DECREASE

Alternative to the gradient scale, tap the minus sign (-) icon to decrementally decrease a selected setting.

SETTINGS

Tap this icon to open the *Settings* screen.

DELAYED START

Tap this icon to open the *Delayed Start* screen.

DURATION

Tap this icon to open the *Bath Time* screen.

LIGHT (Optional)

The Bliss control can operate one(1) or two (2) optional lighting packages purchased with the system. Tap this icon to enable/disable the lights.

BLUETOOTH (Optional)

The Bliss control can operate **ONLY** an optional Bluetooth package purchased with the system. Tap this icon to enable/disable audio.

SECTION 10. INSTALLING SAFETY PLACARDS

Three (3) metal safety placards are included inside the installation instruction envelope packaged with the sauna system.



Figure 57. Caution Placard

1. Position the CAUTION placard in plain sight on the interior wall directly above the sauna heater and attach with the two (2) screws provided.

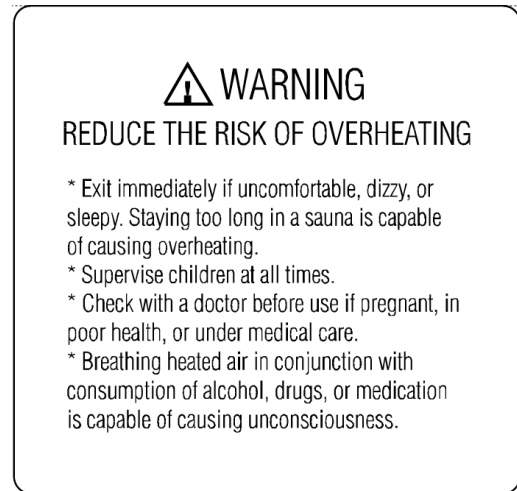

Figure 58. Warning Placard

2. Position the two (2) WARNING placards in plain sight on both sides of the doorway to the sauna.
3. Attach the placards using the eight (8) Screws provided, four (4) screws each.

SECTION 11. PLACING SAUNA ROCKS

The rocks supplied with the heater were selected with the best traditional sauna performance in mind.



HEAVY OBJECT: A full container of rocks is heavy. To avoid injury, bend at the knees when picking up the box.

- Use of other rock types may void heater warranty.
- **NEVER** operate heater without rocks in place!
- **RINSE** rocks with water before placing in the heater.

CAREFULLY place rocks loosely around the heater elements to allow efficient air circulation.

1. Remove the heater guard from the top of the heater.

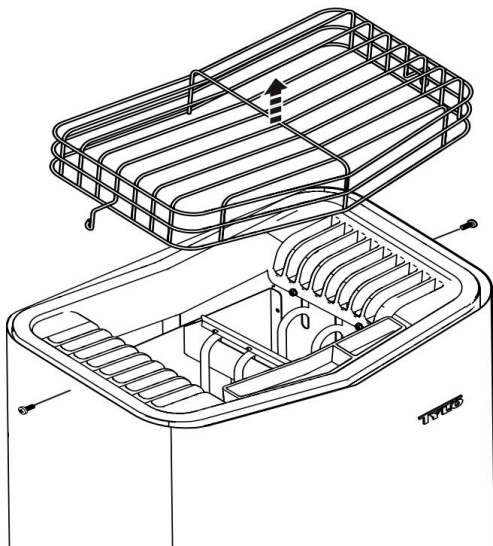

Figure 59. Removing Heater Guard

2. For the first layers, place smaller rocks around the outer perimeter of the heating elements.
3. Fill the middle sections with larger rocks.
4. Ensure the elements stay vertical while carefully filling the heater with rocks.
5. Place rocks loosely in the center of heater to allow heat to rise easily up the middle of heater.
6. Loosely cover the tops of all elements with rocks.

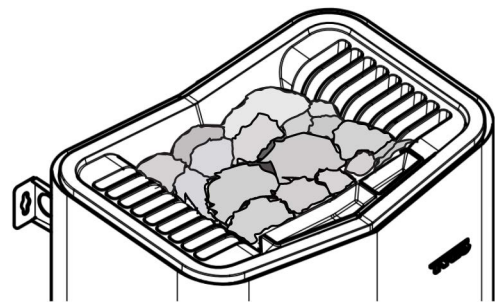

Figure 60. Placing Rocks on Top of Elements

7. Be careful not to pack the rocks too densely on top of the heater elements or onto the side chambers as this can impede airflow.

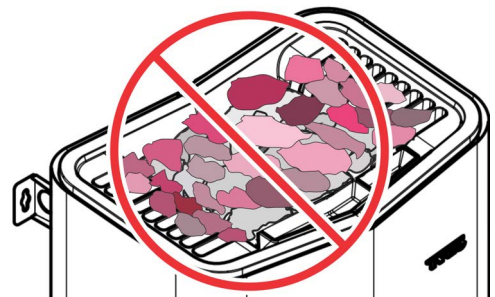
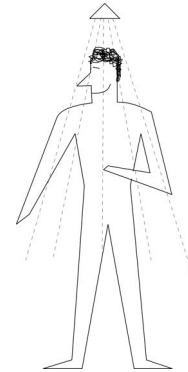

Figure 61. Do Not Pack Rocks Too Densely

8. Re-install the heater guard with the screws removed previously.

SECTION 12. HOW TO TAKE A SAUNA

- Devote adequate time to completely relax while taking a sauna bath.
- Remove clothing and jewelry. Apply a towel loosely about the body.
 - To enjoy the soothing effect of steam, splash a small amount of water onto the heated sauna rock.
 - Use one dipper full (approximately 1/2 cup) of clean water at a time, keeping exposed skin clear of the steam as it rises off the rocks.
 - **DO NOT** use chlorinated pool or spa water, as corrosion damage may result.
 - **DO NOT** smoke, exercise or drink alcoholic beverages while in the sauna room.
- After ten (10) minutes or when perspiration begins, exit from the sauna, relax in the dressing area, followed by a cool shower.
- Stay hydrated, drinking water is best.
- The allotted cool down time should equal the amount of time occupying the sauna.
- Step back into the sauna room and remain for five (5) or ten (10) minutes.
- Repeat the cycle two (2) or three (3) more times. End with a brisk shower, rinsing in cool water.
- Put on clothing only when perspiration has stopped and the body is completely dry.



Shower



Sauna Bathe

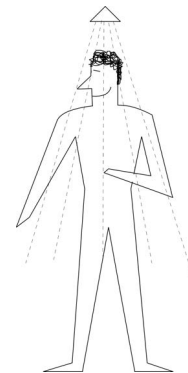

Shower

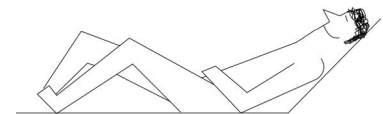

Rest/Relax



Hydrate

SECTION 13. MAINTENANCE

Inspect sauna room at the end of each day the room to ensure the control and system is off.

The sauna, like a bathroom, should be kept clean and odor free. Towels or mats should always be used on benches and floor as perspiration otherwise penetrates the soft wood. To clean and remove perspiration stains, use soap or detergent in warm water, best applied with a scrub brush. Badly soiled surfaces may require sanding. Sand paper wrapped around a wooden block works well.

Air out the sauna often by keeping the door and vents open when the sauna is not in use. Saunas that are in daily use should be washed down at least once a week to keep them clean and the air fresh. Duck board should be removed from the sauna, the sauna floor mopped and dried in a conventional manner, and the duck board thoroughly scrubbed and dried before returning to the sauna room. The sauna heater should be wiped down occasionally with a damp cloth to remove lint and dust. The rocks should be removed once a year for cleaning and small or crumbled rocks replaced.

Benches and supporting structure must be inspected annually for potential deterioration due to age, dry rot or abuse. Any boards with signs of deteriorations should be replaced immediately to avoid possible injury.

SECTION 14. TROUBLESHOOTING

Should you need to contact the dealer or outlet you purchased the product, please have the model and type numbers of the heater, CB Box and control available prior to calling.

14.1. PRE-HEAT MODE

If the air temperature inside the sauna is below 10°F (-12°C) at startup, or if the temperature sensor is not detected, the *CAUTION Pre-Heat Mode* screen appears.

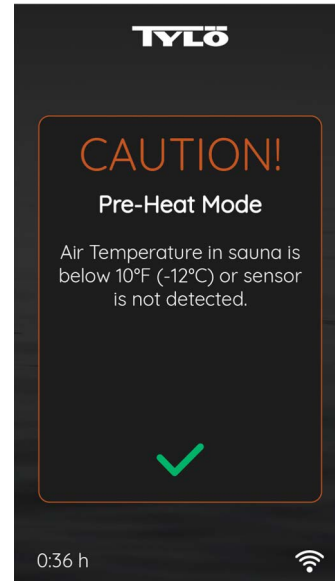

Figure 62. CAUTION Pre-Heat Mode Screen

1. Allow the heater to run for 5 minutes.
 - If the sensor is recognized, the CAUTION screen will go away.
 - If after 5 minutes the sensor is not recognized, the *WARNING Sensor Not Detected* screen appears. and the heater turns off.

14.2. SENSOR NOT DETECTED

When the sensor is not detected, power to the heater is disabled.

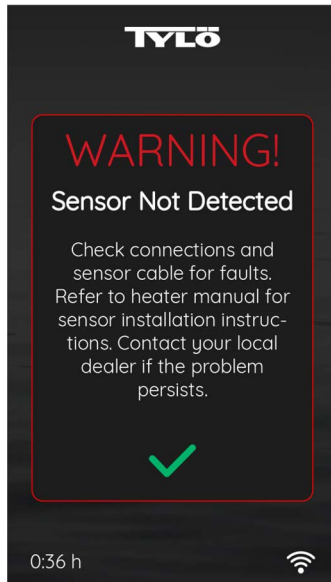

Figure 63.

1. Before performing a visual inspection, turn off circuit breakers to the sauna to remove all electrical power.
2. Refer to the content of the associated **Heater Installation and Operating Instructions** for details on the temperature sensor, cable and CB Box.
3. Check sensor electrical connections at the CB Box and at the sensor, looking for loose or broken wires, loose, corroded, or tarnished connections.
4. Inspect condition of the sensor circuit board for corrosion, tarnish and cold solder joints.
5. If the condition of the circuit board and electrical connections look good, then inspect the whole length of the sensor cable for visible damage.
6. When the inspection is completed and any user-fixable issues are corrected, re-apply power and test the operation of the sauna.
7. If the problem persists, contact your dealer.

14.3. HIGH LIMIT ERROR

When the high limit switch trips/activates, power to the heater is disabled.

While the heater is on and if the temperature at the heater rises above the high limit threshold, the heater shuts off, an audible control alarm is sounded, and the *WARNING High Limit Error* screen appears.

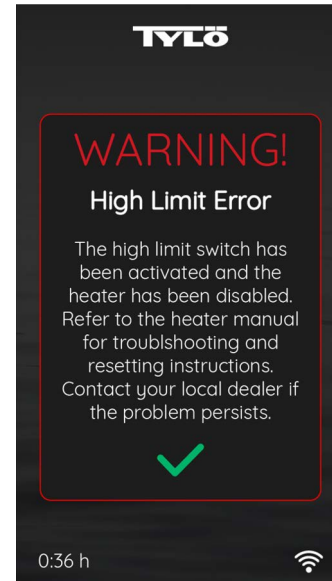

Figure 64.

1. Tap the green colored check mark.
 - The audible alarm turns off and the Home screen with heater off appears.
 - All icons on the Home screen remain functional, except for the **Power** icon.
2. Wait until temperature drops below the low temperature threshold and the high limit resets.
 - If the **Power** icon is tapped before the high limit has had time to reset, the WARNING High Limit Error screen will re-appear.
3. After the high limit has reset, tap the **Power** icon to turn the heater back on.
4. Refer to the content of the associated **Heater Installation and Operating Instructions** for details on sauna ventilation, how the heater is mounted, and placing sauna rocks to diagnose and correct the trouble. If the problem persists, contact your dealer.

14.4. DOOR OPEN

If an optional door switch (not provided by Sauna360) is installed, this message occurs when the control detects the sauna door is open for longer than 30 seconds.

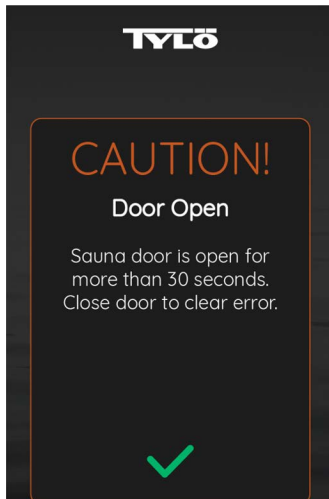

Figure 65. CAUTION Door Open

Close the door within two (2) minutes and the current sauna session will continue and the error message will go away.

If the door is open for greater than two (2) minutes, the **WARNING Door Open** screen appears and power to the heater is disabled.

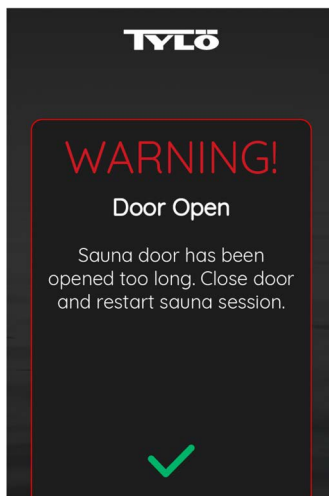

Figure 66. WARNING Door Open

Close the sauna door and press the green check mark, the Home Screen screen appears.

Press the **Power** icon to restart the sauna session.

14.5. JUMPER ERROR

This error occurs when the control detects an electrical jumper is open on the main board located in the CB Box.

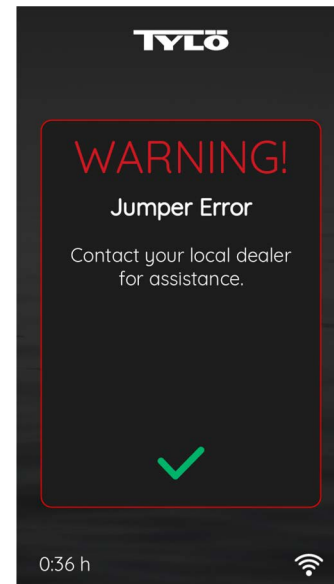

Figure 67.

There are no user-serviceable parts inside the CB Box. Shut off the breakers to the sauna and contact your dealer for assistance.

14.6. INFORMATION

When this message appears, tap the green check mark. Before inspecting, turn off the heater and allow the rocks to cool down before inspection/replacement.

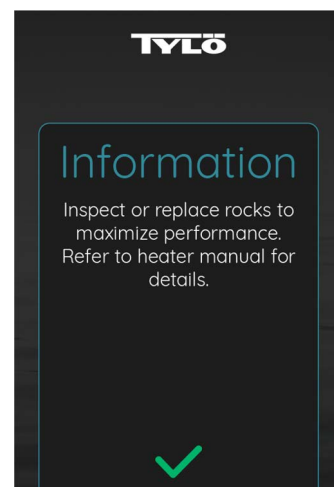

Figure 68.

©2024 Sauna360 Inc.

The Bluetooth® word mark and logos are registered trademarks owned by Bluetooth SIG, Inc. and any use of such marks by Sauna360 is under license.

Apple® is a registered trademark of Apple Inc.

Tylö® is a registered trademark of Sauna360.

SAUNA360
HELP PEOPLE LIVE BETTER

