

# TYLÖ

REDEFINING WELLNESS



SAUNA  
STEAM  
INFRARED

REDEFINING WELLNESS

# Over 75 years of modern wellness

In a world where everything is interconnected, we understand the complex balance between body and mind, work and home, physical and digital. Our sauna, steam and infrared solutions seamlessly integrate with your daily reality, because true wellness thrives when it aligns with your world.

## CONTENTS

About Tylo	4
<b>SAUNA</b>	
Sauna benefits	7
Sauna solutions	8
<b>MODULAR SAUNA ROOM</b>	<b>10</b>
Reflection Sauna Rooms	12
Harmony Sauna Rooms	16
<b>CUSTOMISED SAUNA SOLUTIONS</b>	<b>26</b>
Create your dream sauna	28
<b>SAUNA HEATERS</b>	
Crown heater	50
Traditional sauna heaters	58
Combi sauna heaters	60
<b>CONTROL PANELS</b>	<b>62</b>
<b>ACCESSORIES</b>	<b>64</b>
<b>STEAM</b>	
Steam shower	68
Steam column	70
Steam rooms	72
<b>CUSTOMIZED STEAM ROOMS</b>	<b>74</b>
<b>ACCESSORIES</b>	<b>80</b>
<b>INFRARED</b>	
Infrared sauna rooms	84
Infrared panels	90
<b>COMMERCIAL</b>	
Sauna heaters	94
Steam generators	97
Control panels	97
Panacea Twin	98
Energy consumption	100
<b>CASE</b>	<b>102</b>
<b>CHARTS</b>	<b>116</b>
<b>TECHNICAL INFORMATION &amp; DRAWINGS</b>	<b>120</b>

With reservation for changes in our assortment.  
For the latest version visit [tylo.com/downloads](https://tylo.com/downloads)

# About Tylö

## REDEFINING WELLNESS

With a huge passion for sauna and wellness, solid traditions in craftsmanship and profound knowledge Tylö is redefining the sauna scene by always continuing to create top quality sauna products made to be a vital part of healthy living. When you are investing in a Tylö product, you are not only investing in a product, you are also investing in your health.

## HIGH QUALITY

When you choose a Tylö product, you can rest assured that it has been crafted with the utmost care and attention to detail. Our commitment to quality is evident in every aspect of our manufacturing process. From the selection of raw materials to the final inspection, we take pride in delivering a superior product.

## SUSTAINABLE PRODUCTS

Our commitment to sustainability starts with the materials we use. We select only the finest wood for our saunas, ensuring that every product we create is as environmentally friendly as it is beautiful. Additionally, we are using energy-efficient technology in our heaters to help reduce

your carbon footprint and conserve energy. With Tylö, you can experience the benefits of a high-quality and long-lasting sauna product that is designed with both you and the environment in mind.

## DEVELOPMENT

Years of development, experience and a relentless strive for perfection has lead us to where we are today. Masters of providing relaxation year after year, for you and your health.

## INNOVATIVE DESIGN

Tylö combines modern technology with innovative design to create unique sauna experiences. Offering both prefabricated sauna solutions and customized design options Tylö is your complete partner with endless design options.

## CRAFTED IN SWEDEN

We take immense pride in the artistry of our craftsmanship, precisely produced within our Swedish factory. Every component, from the heating elements to the heater itself, as well as the entirety of the room, is meticulously crafted right here in Sweden.





# SAUNA

## 9 Benefits of sauna

### 1. MUSCLES AND JOINTS

Quicker recovery from exercise by easing joint and muscle pain and eliminating lactic acid build-up.

### 2. CLEANSSES THE SKIN

Deep sweating cleanses the skin, and rinses off dirt, dead skin cells and bacteria.

### 3. LUNG DISEASES

It can have a good effect on asthma and pneumonia.

### 4. STATE OF MIND

Can be used in treatment for anxiety and mild depression.

### 5. BRAIN HEALTH

Regular sauna bathing can lower the risk for both stroke and dementia.

### 6. HEART

It lowers the blood pressure and fights against heart diseases.

### 7. ENERGY

It can help you sleep better and therefore help against chronic fatigue.

### 8. SOCIAL BENEFITS

Relaxing environment for socialising with family and friends.

### 9. LAST BUT NOT LEAST: JUST FEELS GOOD

A sauna not only feels good, it's good for you.

Hägglund, H. (2020). Bastuboken: Heta fakta om bastu och hälsa. Ekerlids Förlag.



# Two ways to build your sauna

## 1. Modular sauna solutions

The perfect choice if you have an open space to place a sauna room in.

### FLEXIBLE SOLUTIONS

Tylö modular sauna rooms are carefully designed to fit into any modern home. The rooms are prefabricated, bundled with smart solutions for fast and easy assembly. A flexible solution designed to fit into a variety of spaces!

### CUSTOM CHOICES

Craftsmanship, solid materials, and attention to detail stand at the core of this modern sauna solution. With a variety of sizes, materials

and finishes, our modular sauna rooms can be customized to fit your specific needs and preferences!

### CONVENIENT ASSEMBLY

Enjoy fast and easy assembly with this convenient sauna solution. The prefabricated modules fit easily together and require no additional framing or insulation. A sauna solution made to fit into modern life!



## 2. Customised sauna solutions

If you have a set space to make into a sauna

### UNIQUE DESIGN

Custom saunas designed to meet your space and specifications. Create your unique sauna experience with customised sauna solutions from Tylö. Custom-built with layouts to suit the space, with your choice of panels, interior and lighting.

### TAILORMADE SOLUTIONS

Whether you would like to choose from our standard assortment or have tailormade solutions Tylö is your complete partner.

### UNLIMITED OPTIONS

Custom-built saunas are designed for the exact shape of your room, making the most of the existing space. Enjoy unlimited options – with innovative use of glass and doors, unusual angles and unique bench configurations.



# Modular sauna room



# Reflection

Introducing Reflection, the new sauna room that gets its name from its stunning smoked glass front that beautifully reflects on the outside. Once you step inside, you'll be greeted by a central portal that leads you to the heart of the room where you can relax and reflect.

- The Reflection room is fully equipped
- Elite control panel built-in
- Beautiful designed Valchromat material on the outside
- Integrated high-quality bluetooth stereo speakers

Read more on [tylo.com/reflection](https://tylo.com/reflection)

The portal's significance lies in its seamless concealment of electronics and lighting within Reflection's design. This perfect blend wraps you in the peace of your surroundings, offering a complete immersion. Adjust the lighting to your liking, change the music, and fully embrace this modern twist on a traditional sauna for a truly comprehensive experience.



## PORTAL

The portal features LED lighting on the side of the portal, three spotlights, a built-in Elite control panel, and integrated high-quality Bluetooth stereo speakers.

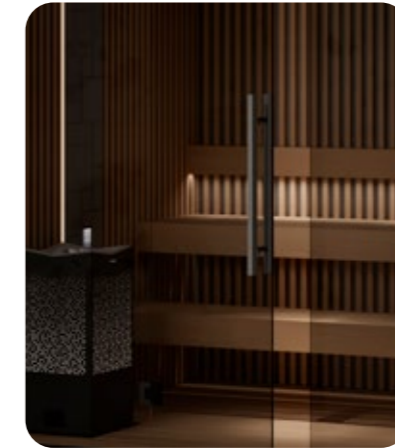

## RIBBED PANELS

Available in Alder and Thermo Alder

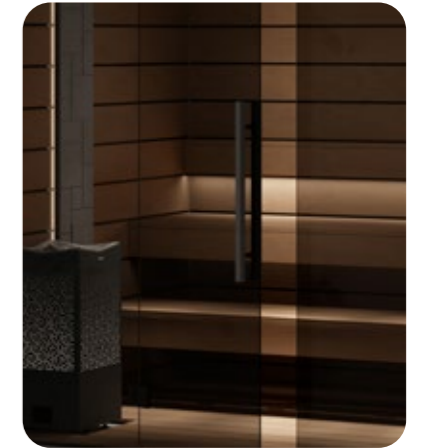

## WIDE PANELS

Available in Aspen and Thermo Aspen

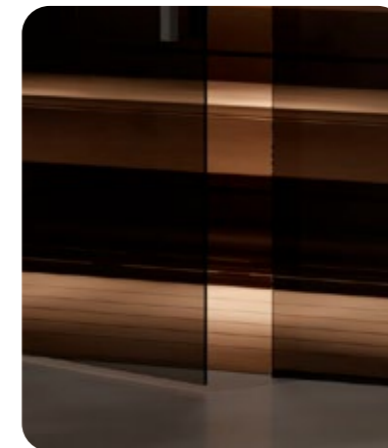

## OPTIONAL FLOOR

You can choose to add floor to your room. Available in Aspen, Thermo Aspen, Alder and Thermo Alder.

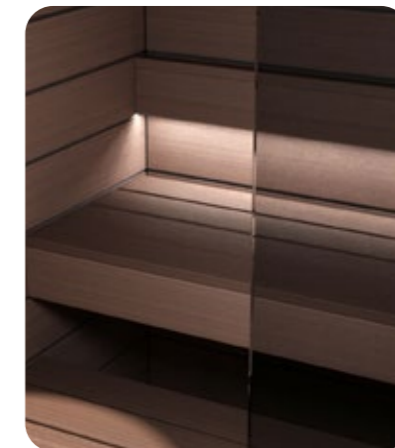

## WIDE INTERIOR

Available in Aspen and Thermo Aspen.

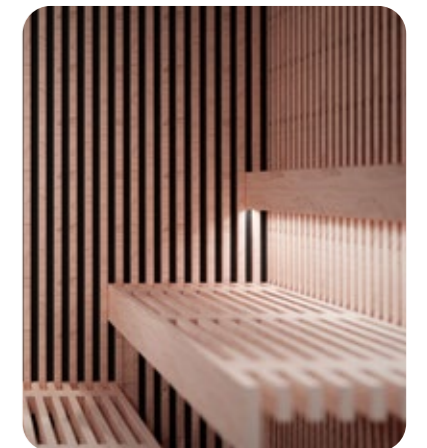

## RIBBED INTERIOR

Available in Alder and Thermo Alder

REFLECTION

# Glass Corner or Glass Front

Choose between a stunning Glass Front or the captivating charm of a Glass Corner for your Reflection Sauna Room, and create a space that's uniquely yours.

## RIBBED OR WIDE?

Opt for our modern ribbed panels and interior in Alder or Thermo Alder, or the soft and smooth wide panels and interior in Aspen or Thermo Aspen.

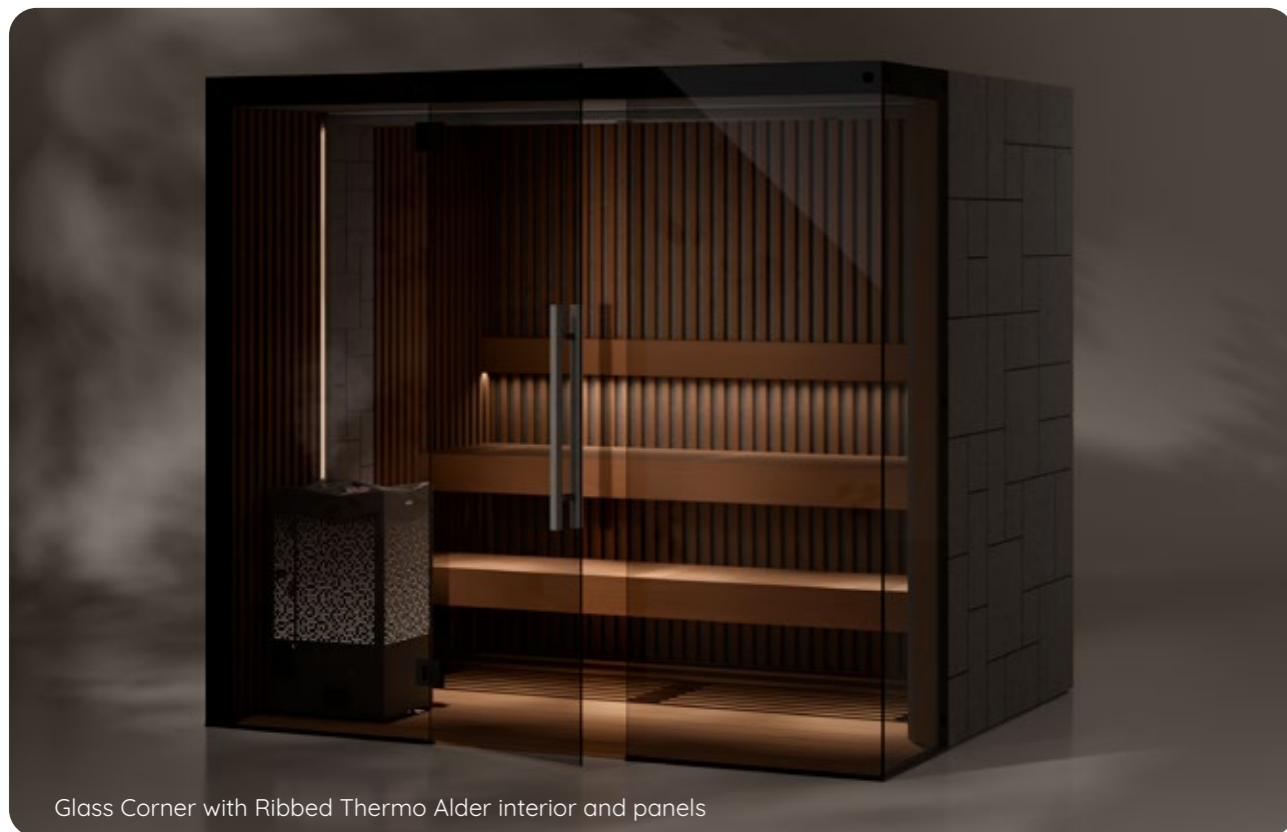

Glass Corner with Ribbed Thermo Alder interior and panels

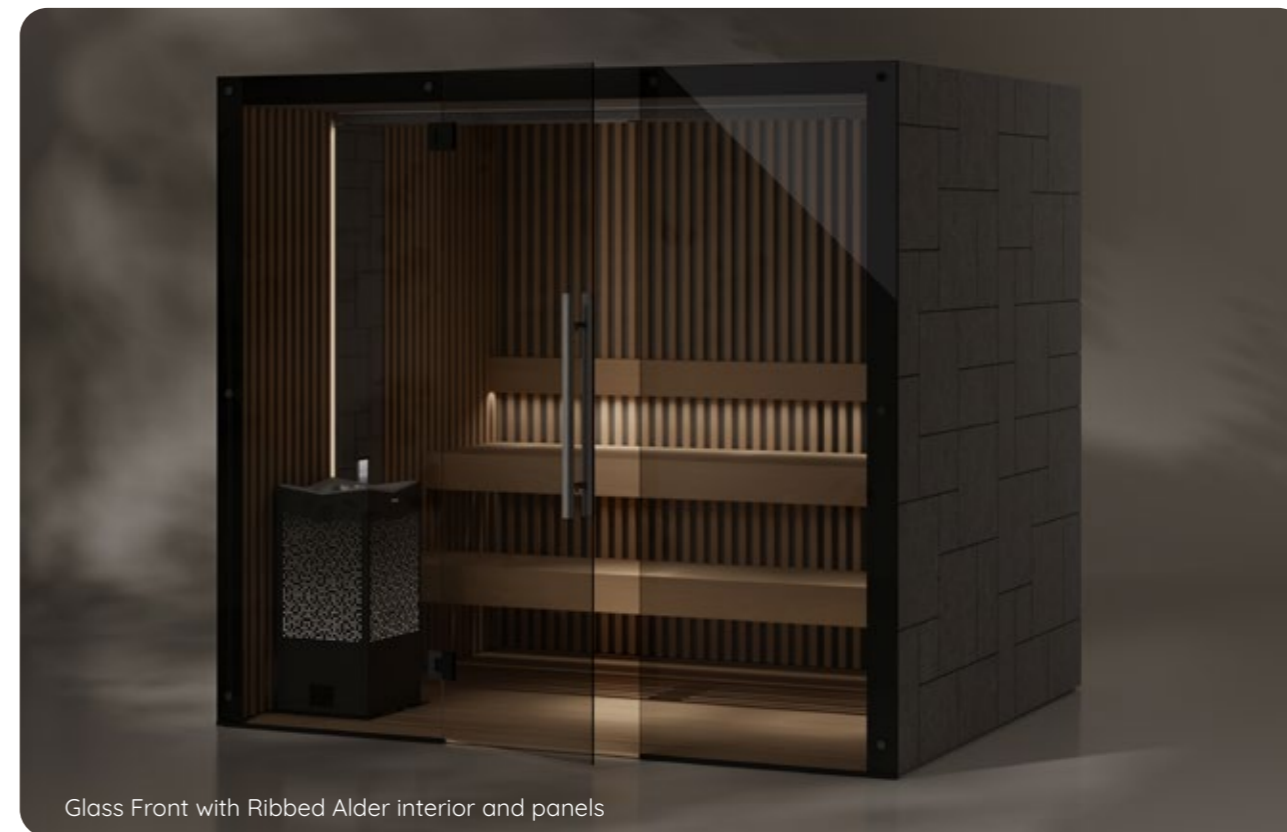

Glass Front with Ribbed Alder interior and panels



Glass Corner with Wide Thermo Aspen interior and panels



Glass Front with Wide Aspen interior and panels



# Harmony

Tylö's modular sauna room Harmony is the solution for those who want a quick and easy route to sauna enjoyment. Your sauna is delivered as prefabricated components that are easy to assemble. It is all set up for installation of electrical systems and the ventilation systems are ready to go. The end result is an attractive and seamlessly constructed sauna where all nails, screws and joints are covered.



Harmony with Glass Corner (lighting is optional)

## Create your Harmony in 7 steps

In just a few easy steps, personalize and modify to fit seamlessly into your home.



### 1. LAYOUT

Choose between square, corner, glass front, glass corner and round corner.

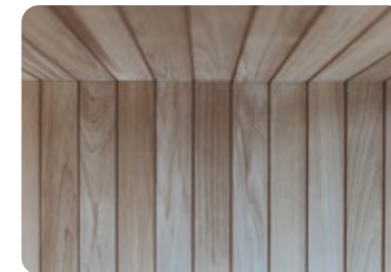

### 2. PANEL

Horizontal or vertical paneling available in different types of wood: Spruce, Aspen and Thermo-Aspen.

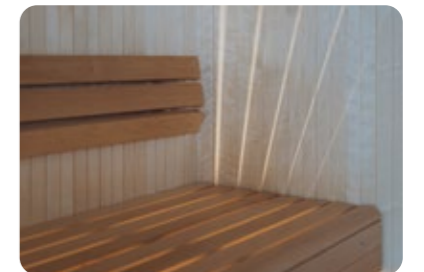

### 3. INTERIOR

Choose between Classic, Slim and Wide benches made of Alder, Aspen or Thermo Alder. Select a closed style with skirting panel or an open style without skirting panel.



### 4. GLASS

You can choose between clear glass, tinted glass or frosted glass.



### 5. DOOR HANDLE

Choose between horizontal and vertical orientation or go for the design handle.



### 6. LIGHTING

Soffits come with built-in lighting.

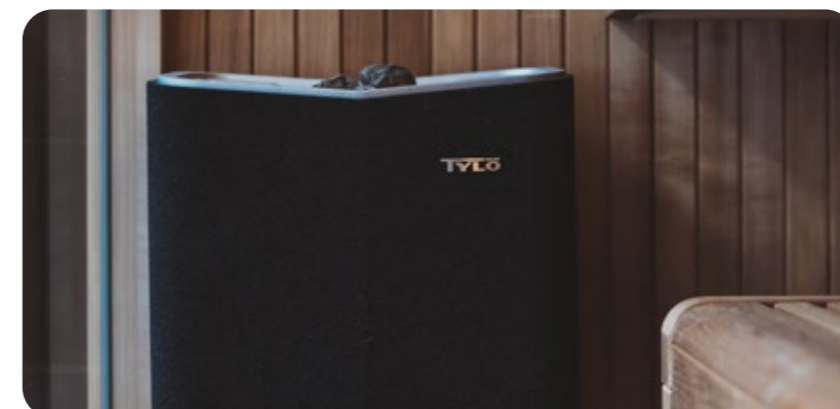

### 7. HEATER

Here it is important to know the size of the sauna. See the compare tool at [tylo.com](https://tylo.com) site or use the table in this catalogue on p. 116.

### BUILD YOUR DREAM SAUNA

Use our sauna builder to create your dream sauna from scratch!



HARMONY

# 1. Layout

You might think a Harmony room is just a fixed module. But it is really adaptable and fits almost any space thanks to all the variations and sizes.



## DAY 1 Delivery & Construction

Prefabricated components delivered as a flat-pack kit.



## DAY 2 Ready for taking a Sauna!



**CORNER**  
Aspen



**CORNER WITH GLAZED SECTION**  
Spruce



**SQUARE**  
Thermo Aspen



**SQUARE WITH GLAZED SECTION, FRONT** Thermo Aspen



**SQUARE WITH GLAZED SECTION, SIDE** Aspen



**SQUARE WITH GLAZED SECTION, FRONT & SIDE** Spruce



**GLASS FRONT**  
Thermo Aspen



**GLASS CORNER**  
Aspen



**SQUARE WITH ROUND GLASS CORNER** Aspen

The height is always 2073 mm and the smallest measurement is 1200 x 1200 mm. Then you can make it as big as you want, also for professional use like spas and swimming halls. We have gathered some examples here below. Drawings and more information about Harmony can be found at [tylo.com](https://tylo.com)

Or build your Harmony sauna in our 3D configurator



## HARMONY

## 2. Panel

Discover our high-quality sauna panels in various designs that perfectly match your Harmony's interior design. Choose between vertical or horizontal arrangements for a customizable and elegant sauna experience.



Thin Aspen, vertical.



### ASPEN

Aspen is a light, relatively soft and brittle wood that is stable in shape when moisture changes. It has low thermal conductivity and does not release resin and is therefore commonly used for sauna material.

Available in 15 x 85 mm and 15 x 240 mm



### THERMO ASPEN

The heat-treated aspen has a much darker shade than non-treated. It is a form stable wood because dryer than non-treated and absorbs less moisture.

Available in 15 x 85 mm and 15 x 240 mm



### THIN ASPEN

Give your sauna a trendy look with these Thin Aspen panels that give a ribbed feeling. Made from the highest quality that will give your sauna a modern Scandinavian touch.

Size: 12 x 85 mm

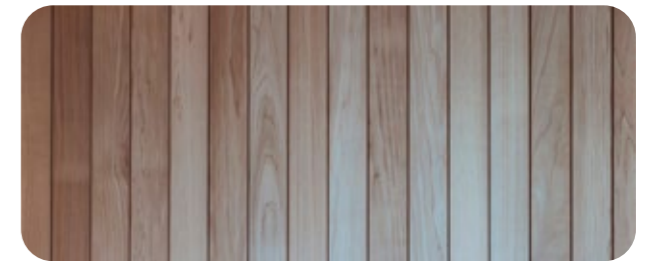

### THIN THERMO ASPEN

Give your sauna a trendy look with these Thin Thermo Aspen panels that give a ribbed feeling. Made from the highest quality that will give your sauna a modern Scandinavian touch.

Size: 12 x 85 mm



### BRUSHED THERMO ASPEN

Brushed Thermo Aspen panels offers a luxurious panel with a rustic feeling. The unique brushed surface gives an authentic look and feel that will make your sauna unique from others.

Size: 12 x 85 mm

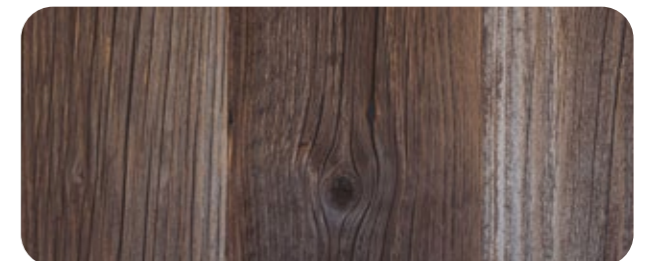

### DRIFTWOOD

Give your sauna a rustic feel with our Driftwood panels. Wood is, and will always remain, a natural product. Therefore, it can be variations and differences between the boards.

Size: 2500 x 1250 x 16mm



### SPRUCE

Spruce is one of the most common trees in the Nordic countries. The spruce is light in colour and is a medium soft type of wood.

Size: 12 x 85 mm

HARMONY

# 3. Interior

Harmony interiors are available in a number of different designs and are made to match the style of your Harmony. Your sauna room can be designed to custom standards by choosing from several types of wood and designs.

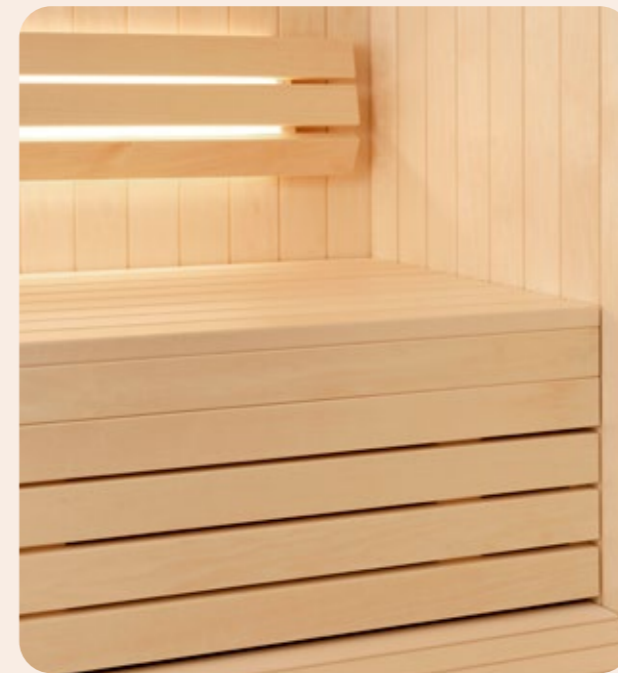

**CLASSIC**

The Classic range of solid Aspen, Alder or Thermo Alder sauna interior is available in pre-cut measurements or may be cut to individual preferences. The range includes benches and back rests with available skirting and side panels (see page 31) for a complete and finished look.



**SLIM**

Classic Slim sauna interiors in Aspen, Alder or Thermo Alder are available in pre-cut measurements but may be cut to individual requirements for custom builds. The range includes benches and back rests with available skirting and siding for a complete and finished look.



**ASPEN**

A light and relatively soft wood that is the most popular wood on sauna interior.

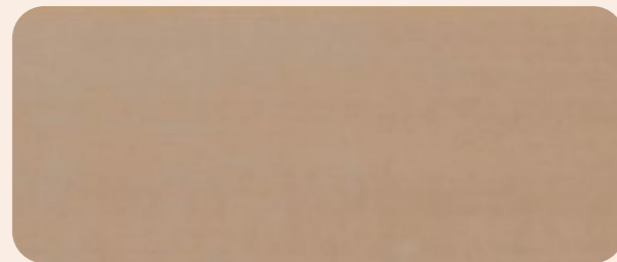

**THERMO ASPEN**

Heat treated aspen is dark and is a good match to thermo aspen on the walls.



**ALDER**

A softly reddish wood that doesn't secrete resin. Can shift a bit in colour over the course of time.

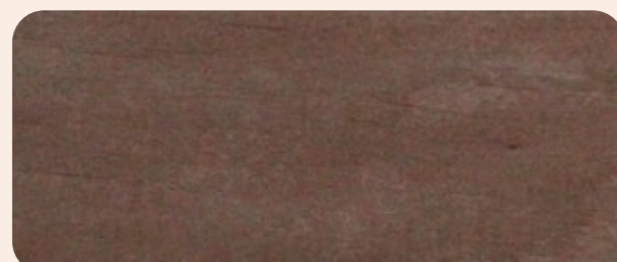

**THERMO ALDER**

A heat treated alder is dark and is a good match to thermo aspen on the walls.

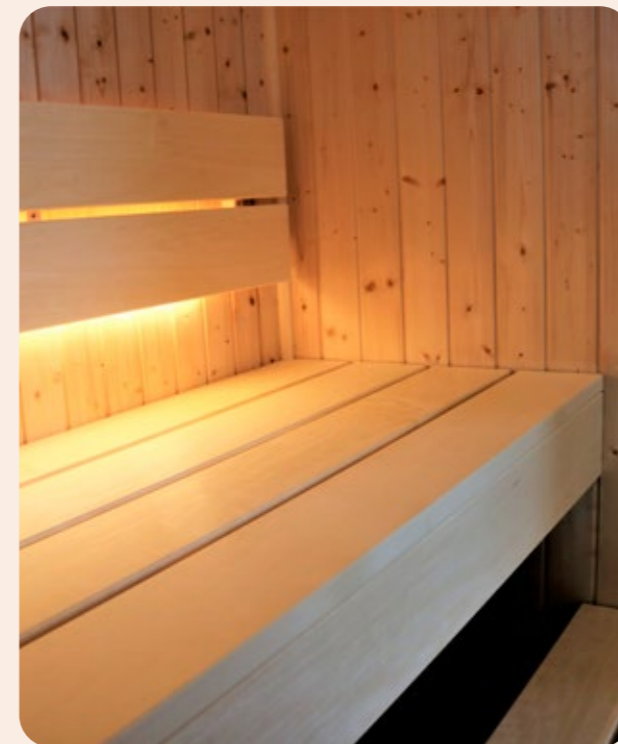

**WIDE**

The Classic Wide range of Aspen, Alder or Thermo Alder. The sauna interior is available in custom measurements as flex interior. The range includes benches and back rests.

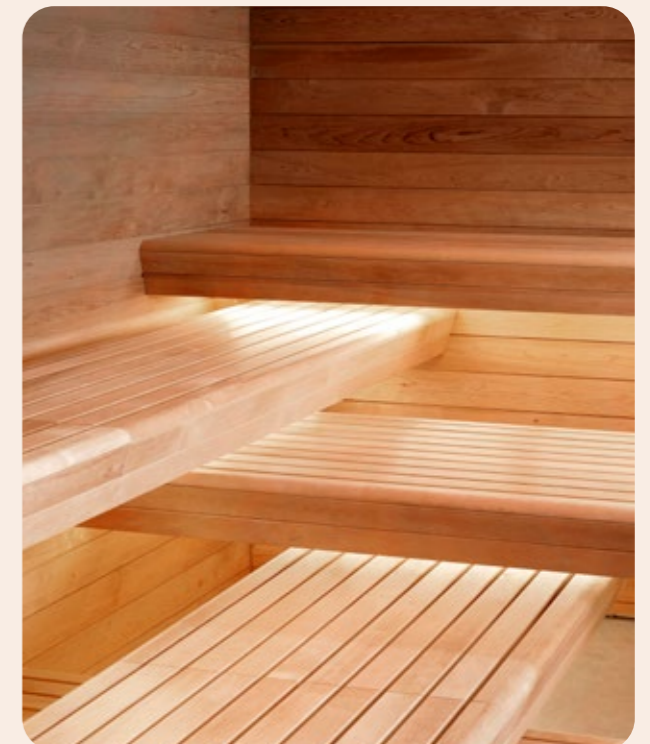

**PANORAMA**

The Panorama range of sauna benches with the overlapping design are made of Aspen, Alder and Thermo Alder and are available in custom measurements as flex interior. Also option with wide bench boards.

HARMONY

# 4. Glass

Whether it's a door glass, glass section or glass front, our glass products are engineered to endure significant temperature variations between sauna interior and exterior, maintaining their shape and integrity.

Opt for clear glass for an open ambiance, bronze glass for added warmth, or frosted glass to create a private, relaxing retreat.

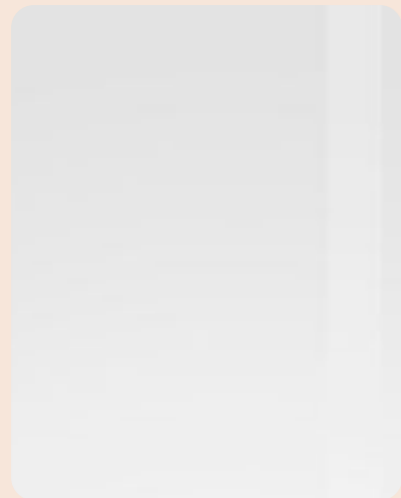

**CLEAR GLASS**

8 mm tempered safety glass.



**BRONZE GLASS**

8 mm tempered safety glass.

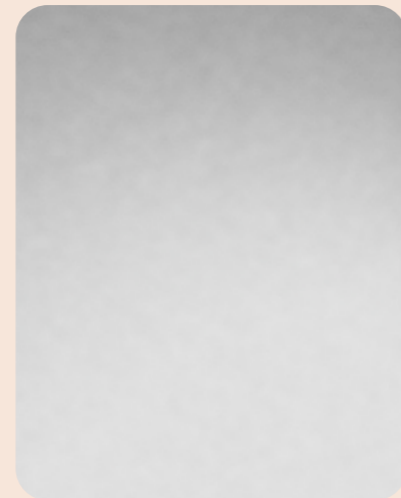

**FROSTED GLASS**

8 mm tempered safety glass.

HARMONY

# 5. Door handle

Choose between horizontal and vertical orientation or go for the design handle.



**HORIZONTAL**



**VERTICAL**



**DESIGN HANDLE**



**HORIZONTAL  
ALU LINE\***



**PANACEA\***

\*not as standard, needs special order.

HARMONY

# 6. Lighting

Tylö offers an extensive range of sauna lights for the Harmony model. Hidden lights behind benches and backrests creates a comfortable atmosphere, while lamps mounted on the wall or in the ceiling offers a more distinctive look. See all lighting solutions on page 42-47.

For exterior lighting, opt for a soffit that seamlessly integrate into the exterior design.



**WITH SOFFIT**



**WITHOUT SOFFIT**

HARMONY

# 7. Sauna heater

Find the heater for your sauna on page 48-61.



SAUNA

# Customised sauna solutions



# Create your dream sauna in 7 steps

Do you have a space waiting to be transformed into a sauna? Whether it's a small closet or a spacious room, you can customize it panel by panel. Enhance the look with fresh taika designs on the walls and new benches. Choose from standard options or contact a dealer for a personalized sauna just for you.

Build your dream sauna step by step:

## 1. SAUNA PANELS

Choose from a wide range of options: from modern Taika panels, classic Spruce, or heat-treated Aspen or Alder panels to more unique designs like brushed or driftwood panels. Install them horizontally or vertically to achieve your desired look. Ensure proper insulation with at least 45 mm thick mineral wool. Leave an air gap between the outer wall and sauna insulation if against a cold outer wall. Remember to build the sauna as a separate 'room in room' structure.

## 2. INTERIOR WOOD

Match the wall panels or create a beautiful contrast with benches and backrests. Opt for slim or wide boards in a classic or creative floating bench design.

## 3. EXTRAS

Add comfort and style with skirting, floor grating, armrests, or side panels.

## 4. GLASS FRONTS AND CORNERS

Enhance the luxury factor with glass fronts and corners. Choose our durable, prefabricated glazed sections made of safety glass.

## 5. DOORS

Ensure outward-opening sauna doors sealed with a magnetic lock, self-closing hinges, or equivalent for easy access. We recommend using professionally made sauna doors.

## 6. HEATER

Select the appropriate sauna heater based on the volume of the sauna room. As a rule of thumb, use approximately 1 kW per 1.3 m<sup>3</sup> of room volume. For saunas with large glass surfaces or heavy wall materials, adjust the power accordingly.

## 7. LIGHTS

Customize the sauna lighting to your preference. Conceal lights under benches and backrests for a cozy ambiance or choose retro-style lamps for wall or ceiling placement.

## Important to get right

### THE VENTILATION

The best functioning ventilation is given on the simplest way - traditional self-pull principle, with supply air opening through the wall under the heater and exhaust air vent on the wall diagonally over the room. The inlet air and the exhaust air should always lead to the same space.

The air circulation of the door shall cooperate with the hot air from the heater. Therefore, the heater is placed on the same wall as the door. The inlet air valve is placed directly through the wall in the middle of the heater.

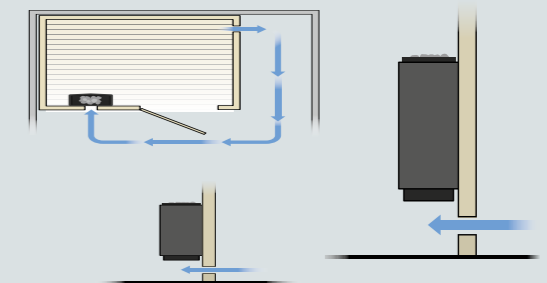

# 1. Sauna panels

Tylö's beautiful sauna panels can be placed either horizontal or vertically to create the look you want. If you need another kind of wood, contact your dealer for special designs.

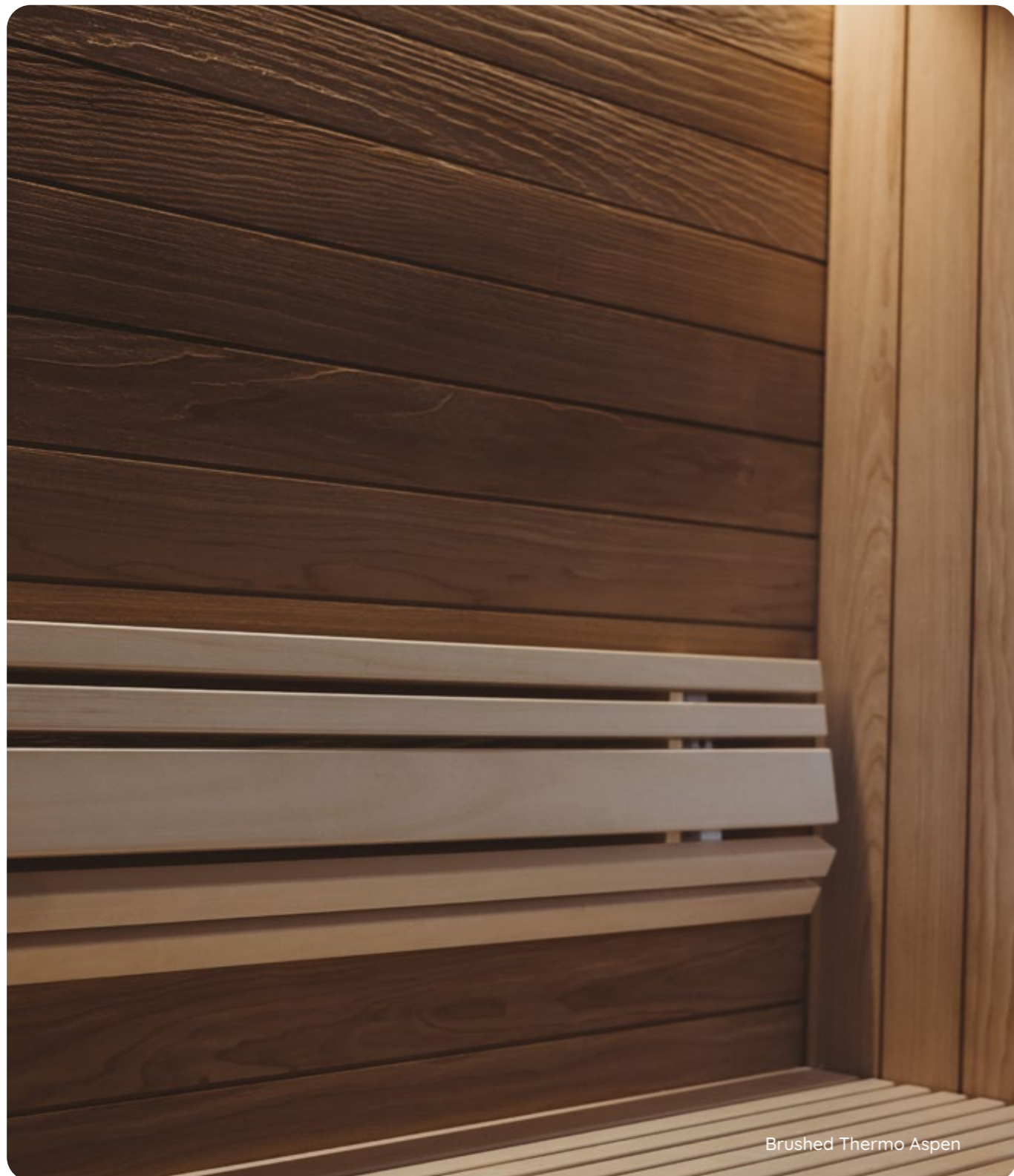

Brushed Thermo Aspen



**ASPEN**  
Beautiful light Aspen panels creates a clean and minimalistic look. Available in STS and STP profile.



**THERMO ASPEN**  
Heat-treated aspen creates a warm brown panel, for a elegant and luxurious feeling.



**THIN ASPEN**  
With ribbed aspen panels of the highest quality, the sauna room gets a modern Scandinavian touch.

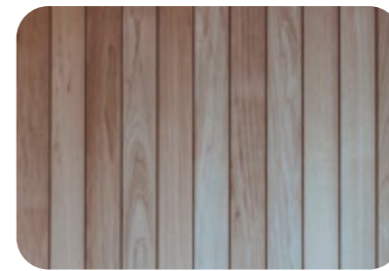

**THIN THERMO ASPEN**  
Thin thermo aspen panels gives the room a trendy look with a high sense of design.

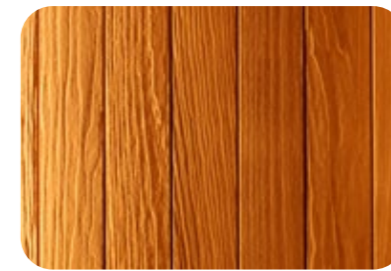

**BRUSHED THERMO ASPEN**  
The unique, brushed surface gives an authentic look that will make your sauna unique from others.

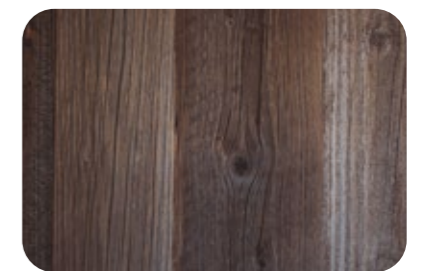

**DRIFTWOOD**  
Give your sauna a rustic and natural feel with driftwood panels in natural grey.



**SPRUCE**  
Light Spruce panels for a traditional and Scandinavian feeling in your sauna.

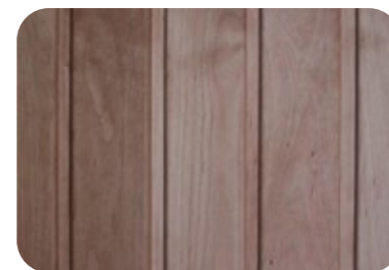

**ALDER**  
Alder panels gives your room a trendy, yet warm and cosy feeling with a high sense of design.

## Aspen is available in two different profiles:

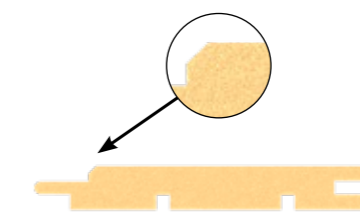

1. SAUNA PANEL STP PROFILE

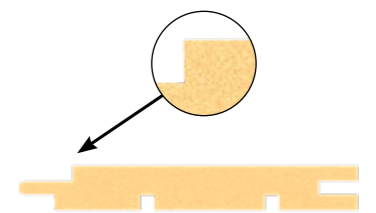

2. SAUNA PANEL STS PROFILE

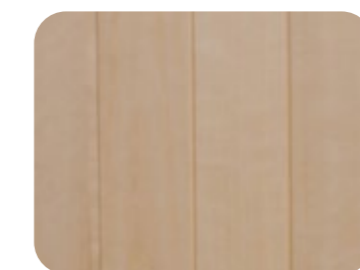

**STP ASPEN**  
STP profile panels has rounded edges that creates a soft look.



**STS ASPEN**  
STS profile panels has square corners that offers a modern look.



# Taika panels

Give your sauna a modern look and feel with Taika panels. It is a perfect solution if you are looking for a contrast in your sauna. The boards are wider than the standard ones and can be placed horizontal or vertically.



**BLACK**



**GREY**



**BROWN**



**UNTREATED**



**WHITE**

## ELEVATE THE SAUNA EXPERIENCE

The Taika panels allow you to effortlessly create an inviting and striking style for your sauna.

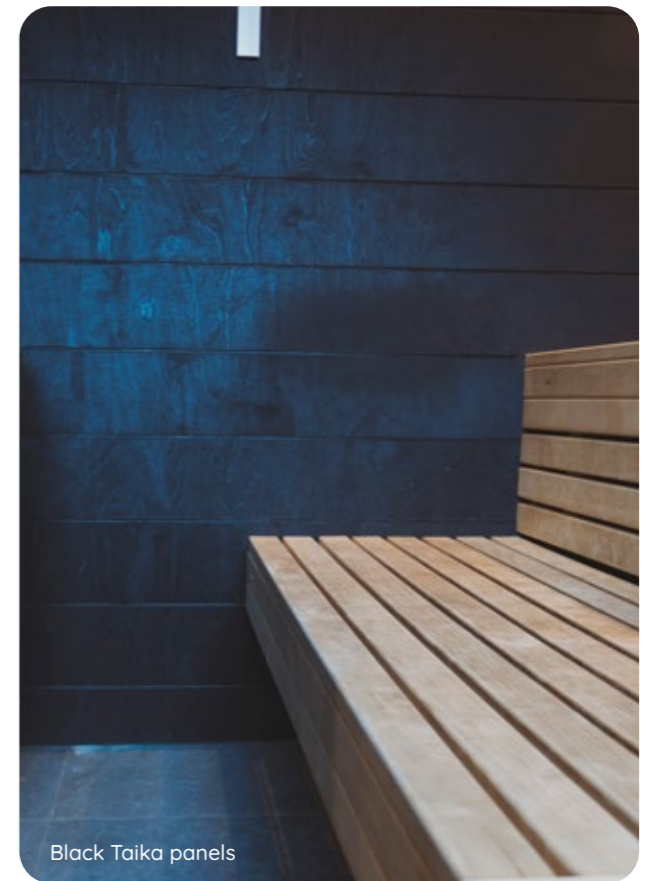

Black Taika panels



White Taika panels

## 2. Interior

From traditional interiors to a creative solution. Choose between a range of standard interiors such as Classic, Wide, Slim, and Panorama, or explore the option of tailormade solutions.

All interiors are available in Aspen, Alder, Thermo Alder and Thermo Aspen.

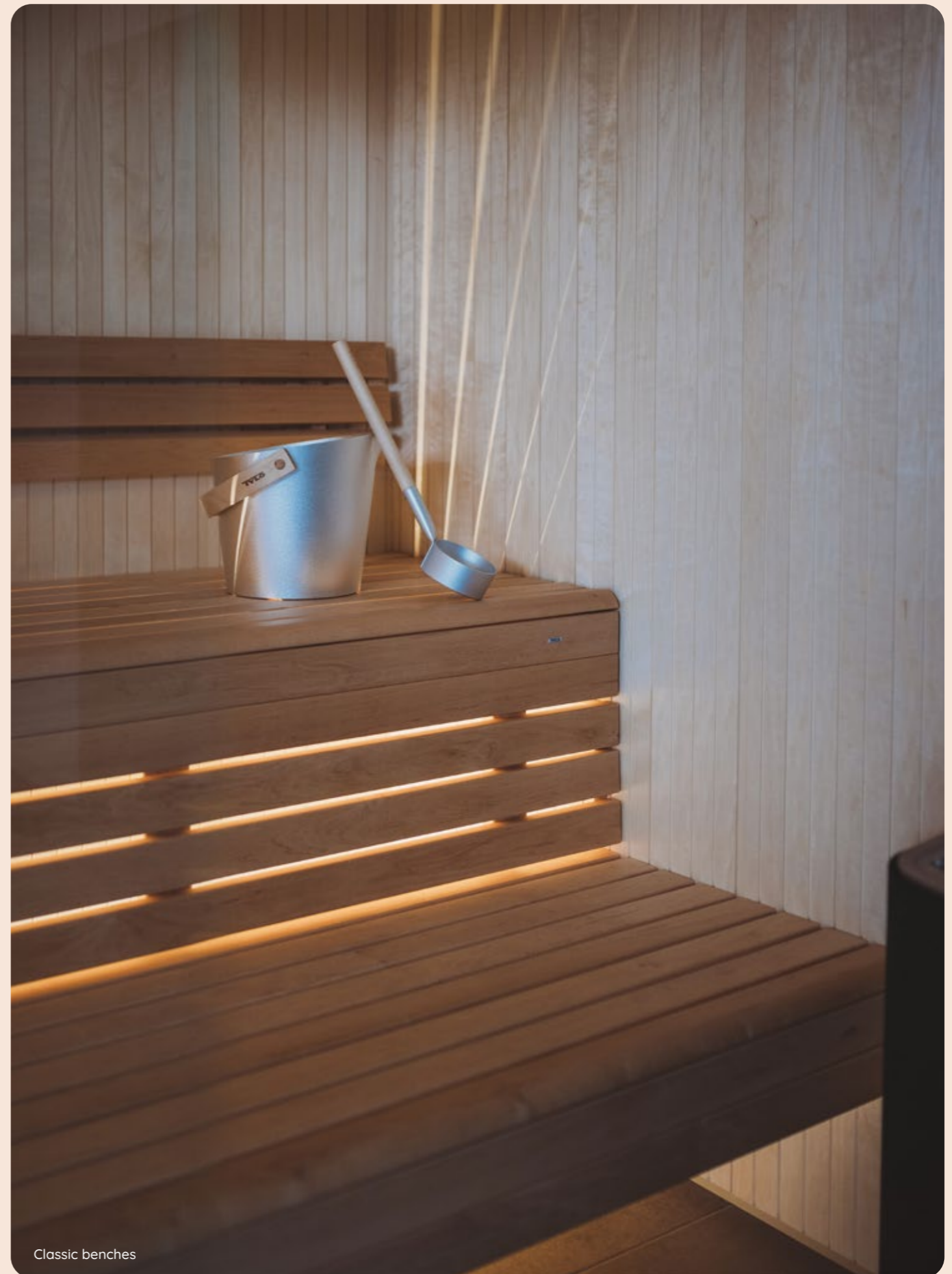
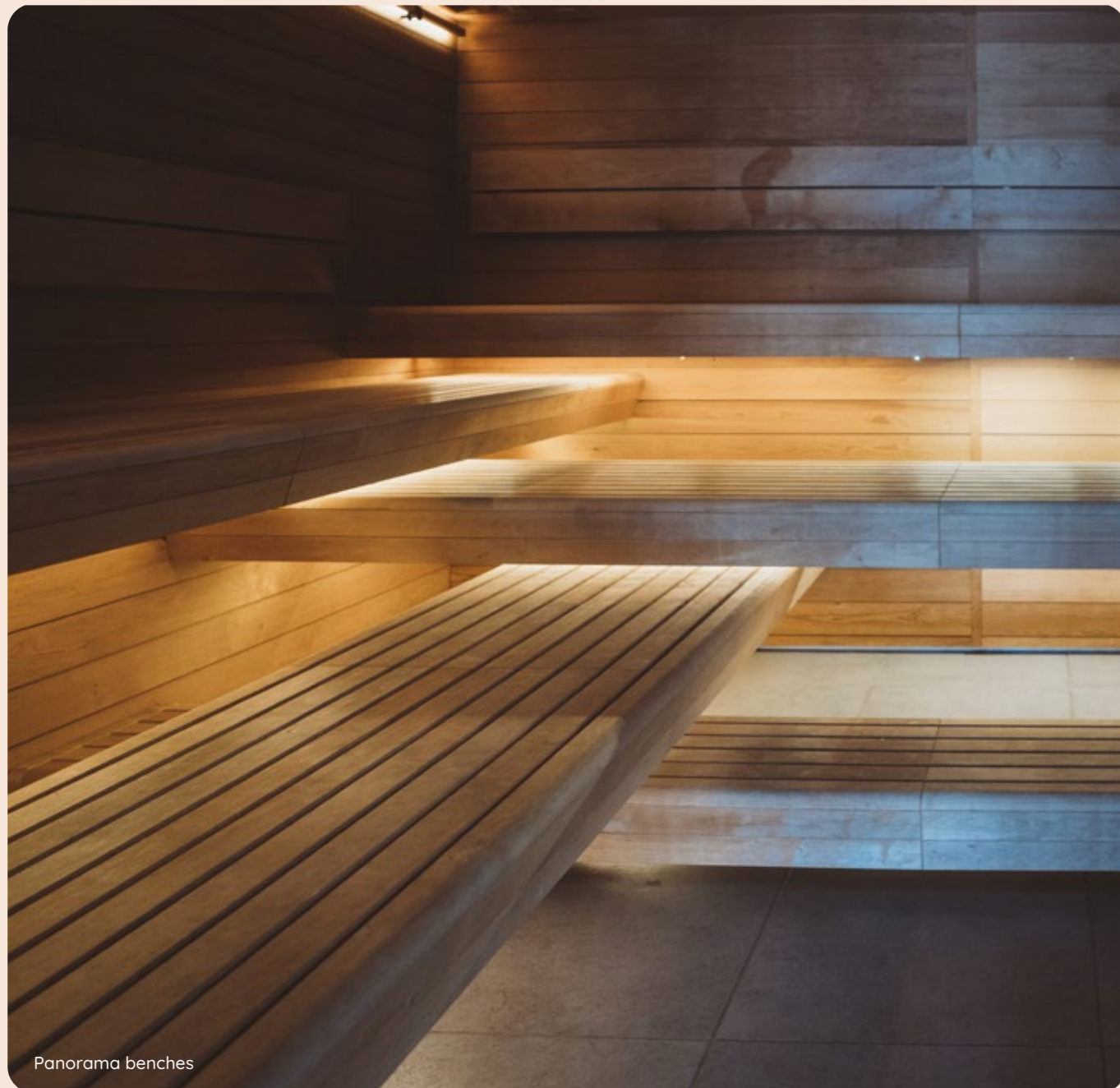



Slim benches

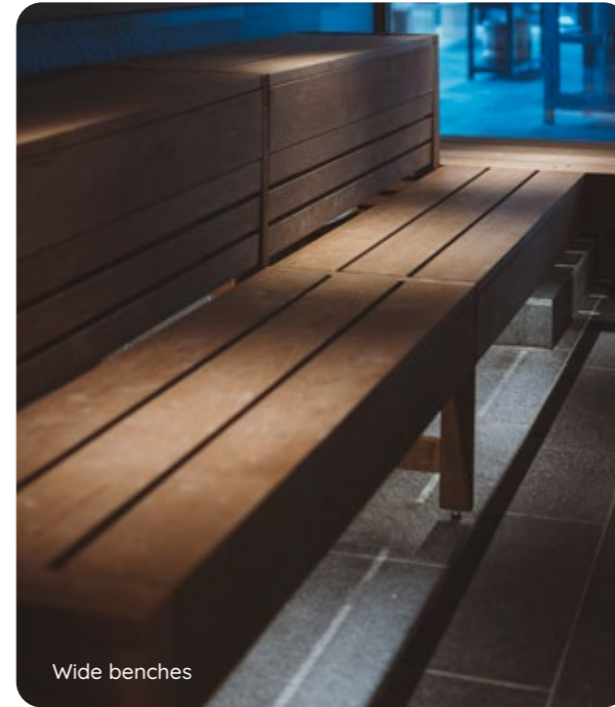

Wide benches



**ARMRESTS & SIDE PANELS**

For settings where the ends of sauna benches are not fixed against a wall or other support

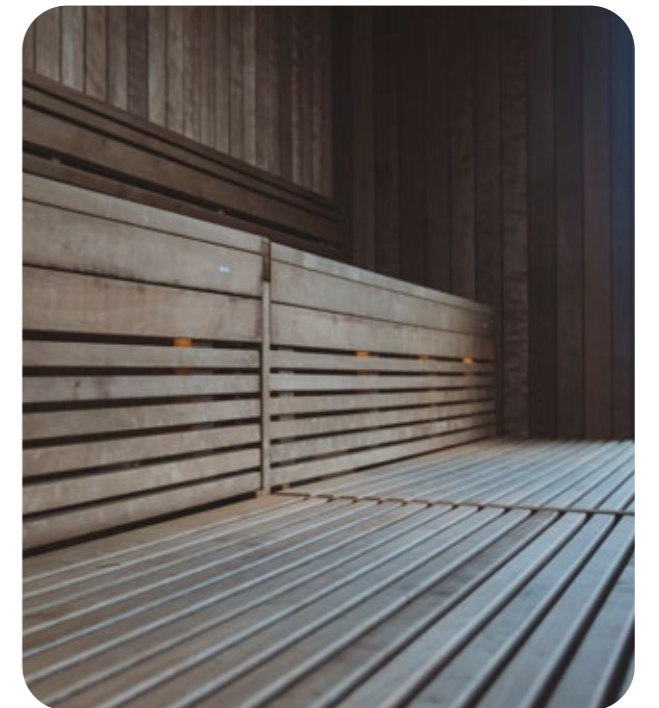

**SKIRTING PANELS**

Prefabricated skirting panels screen off the gaps between the benches.

### 3. Extras

Add the extra comfort and finish the look with skirting, floor grating, armrests or side panels.



**HEADREST**

Our sauna headrest is made from high-quality and durable material, making it perfect for use in moist environments. Available in Alder and Aspen

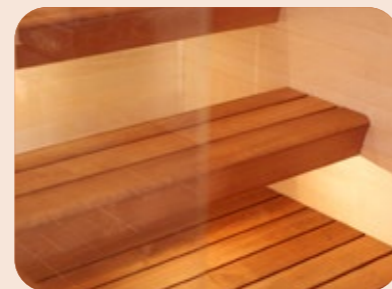

**FLOOR GRATING**

The floor decking feels smooth and pleasant beneath your bare feet and adds a sense of luxury and comfort.

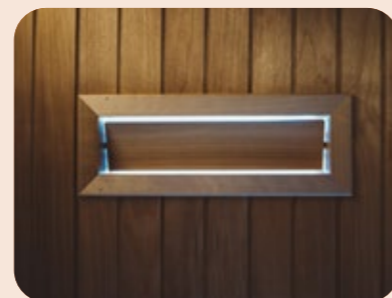

**VENTILATION HATCHES**

For proper function of your sauna heater and for efficiency and longevity of your sauna, well-tuned ventilation is a must

**ADJUSTABLE HEADREST**

With multiple adjustment options, you can easily adjust the pillow to find the perfect position for your head and neck. Available in Alder and Aspen

### 4. Glass fronts & corners

There are many possibilities when constructing saunas with our prefabricated glazed sections, crafted from durable safety glass. With a variety of sizes and configurations available, TyLö ensures that each sauna exudes a distinctive contemporary design, making it a standout feature in any setting.





## 5. Doors

Our top-quality doors are specially manufactured to withstand the considerable temperature differences between the outside and inside of the sauna without warping or becoming deformed.

Would you like a sauna door with different dimensions or made from different materials? Contact a Tylö dealer for a quote.



### 1. SAUNA DOOR DGL

An exclusive no-threshold sauna door featuring tempered 8 mm safety glass. Its sturdy aluminum hinges come with an elegant stainless steel housing, and the frame is equipped with a magnetic strip closure.

### 2. SAUNA DOOR DGB

Robust sauna doors made of tempered 8 mm safety glass, with no threshold and a convenient magnetic strip closure on the handle. The finger-jointed standard frame is crafted from pine.

### 3. DGL/DGB WITH FOUR HINGES

For added stability, both DGB and DGL doors can be equipped with four sturdy hinges. These doors have no threshold and offer easy access, including for disabled users due to their generous width.

### 4. SAUNA DOOR ALU LINE

A stunning sauna door boasting durable tempered safety glass and an attractive design. The exterior features an aluminum handle, while the interior showcases alder strips and a handle. Surrounding the door blade is a stainless steel molding, perfectly complementing the elegant door handle. Available in clear or bronze-tinted glass, the Alu Line door can be ordered as a left or right-handed configuration.

More information can be found at [tylo.com](https://www.tylo.com)

# 6. Lighting

Enhance your sauna experience by selecting the perfect lighting arrangements that best suit your desires. Whether you prefer a warm and inviting atmosphere with concealed lights tucked under benches and backrests, or seek a more contemporary touch with elegantly placed lamps on the walls or ceiling, we have options that cater to your preferences.



## SAUNA SPOTLIGHTS

With these stylish spotlights in black, white or silver you can change the mood in your sauna with just a flick of a switch. These modern spotlights offer both functionality and aesthetics. You can easily install them in the ceiling of your sauna and customize the lighting according to your preference.



1. SPOT LED Silver



2. SPOT LED White



3. SPOT LED Black

## WALL & CEILING

Lamps in the ceiling or on the wall allow for creative and customizable lighting solutions that add character and ambiance to any sauna room.



1. CLASSIC  
Black, frosted glass  
Wall-mounted



2. OHM 100/110  
Black, frosted glass  
Wall-and ceiling-mounted



3. OPUS  
Black  
Wall-and ceiling-mounted



4. OHM 100/170  
Black  
Wall-and ceiling-mounted

## HIDDEN LIGHTS

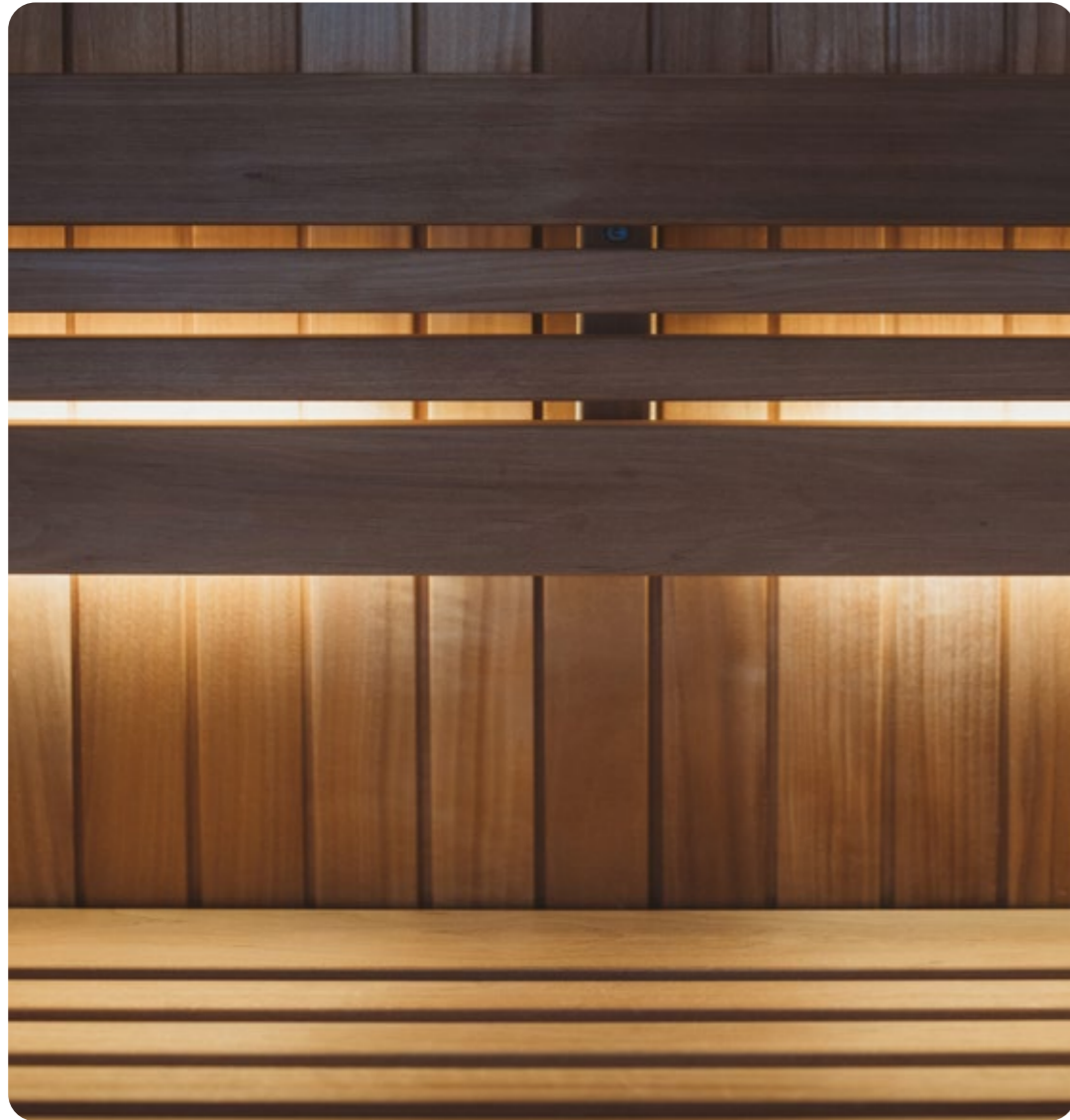

Create the perfect relaxing environment with our discreet hidden lights. Place behind the backrest or under the benches for a harmonizing ambiance that transforms your sauna.

### SAUNA LED LIGHTING

Dimable lights to place behind the backrest.

## STAR LIGHTS



### RUBEN SKY LED

Create your own starlight sky with our star lights. Ruben sky LED creates a unique atmosphere and elevates your sauna or steam room experience to a whole new level of relaxation. The included control gives you a choice of seven pre-installed programmes or the option of creating your own programme with as many as 20 colour changes.

Mix and match your way to perfect lighting with custom combinations! The Silhouette series includes Silhouette Ring and Silhouette Line that each comes in three sizes. This variety of options allows you to create a truly unique lighting scheme in your sauna room.



#### SILHOUETTE RING

The elegant design of Silhouette Ring gives a soft, ambient light that creates the perfect atmosphere in any sauna room. With endless possibilities, it can be hung as a pendant or on the wall, glowing for itself or together with other luminaries from the same series. The lighting is sauna proof and withstands sauna temperatures.

- Ø: 40, 50 & 60 cm
- Available in Aspen
- Combine with dimmable IR-eye for easy monitoring

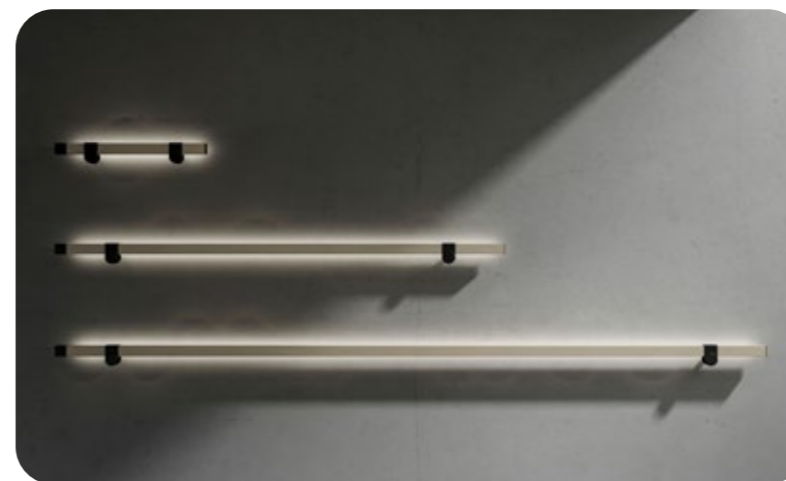

#### SILHOUETTE LINE

Minimalistic Silhouette Line comes in different sizes, allowing you to combine and create your unique sauna lighting. Silhouette Line can be rotated 360 degrees, creating endless combinations to suit the mood of your space. The lighting is sauna proof and withstands sauna temperatures.

- L: 40, 120 & 190 cm
- Available in Aspen
- Combine with dimmable IR-eye for easy monitoring



With a little creativity and imagination, you can use multiple light sources from the series to create unique constellations that add a personal touch to your sauna room.

## SAUNA LIGHTING

# Silhouette

Silhouette is a luminous series that transforms your sauna in unique ways. With its sleek design and endless possibilities Silhouette challenges the perception of sauna lighting. A revolutionary lighting solution for your sauna, offering endless creative possibilities.



SAUNA

# Heaters



## 6 Strong reasons to choose Tylö

### 1. FAST HEATING

Tylö heaters all heat your sauna room up to twice as fast as any other heater. Tylö's unique Intelliair system; dynamic air chambers provide enhanced hot air distribution while the patented divided output feature enables energy savings of up to 30%.

### 2. ENERGY EFFICIENCY

All Tylö heaters are equipped with advanced split output functionality that reduces power output once set temperature is reached.

### 3. SUPERIOR SAFETY - THERMOSAFE™

Besides overheating cut-offs, thermostats and temperature sensors Tylö's heaters comes with Thermosafe™, a unique protective coating guarding against accidental burns.

### 4. ENDLESS OPTIONS

Innovations and technical progress has made it possible to customize your sauna experience. With Tylö's combi heaters you can set the temperature and humidity according to your taste and combine as you wish. Read more on page 58.

### 5. MADE IN SWEDEN

Tylö heaters provide ultimate sauna experience through careful Swedish design, in-house production, and meticulous quality control, ensuring reliability, long-lasting performances, and a worthwhile purchase. Made in Sweden since 1949.

### 6. HIGH QUALITY

Our commitment to quality is evident in every aspect of our manufacturing process. From the selection of raw materials to the final inspection, we take pride in delivering a superior product.

## SAUNA HEATERS

## Crown

Tylö Crown heater lives up to its regal name. From its majestic crown-shaped grill to its impressive lighting pattern, this heater exudes elegance and sophistication. By combining stunning visuals with advanced technology, we have created a heater that stands out in both form and function, providing you with a truly memorable sauna experience.



This floor-standing sauna heater has a symmetrical design combined with elegant lighting pattern that casts a warm glow across the room, creating a serene and relaxing ambiance. The eye-catching Crown grill allows optimal airflow and heat circulation throughout the sauna, making sure that you receive the full benefits of the heater's technology.

**INTELLIAIR AIR CHAMBERS**

IntelliAir air chambers that speeds up air and heat distribution.

**FLOOR STANDING**

This floor standing heater is equally appealing from all sides.

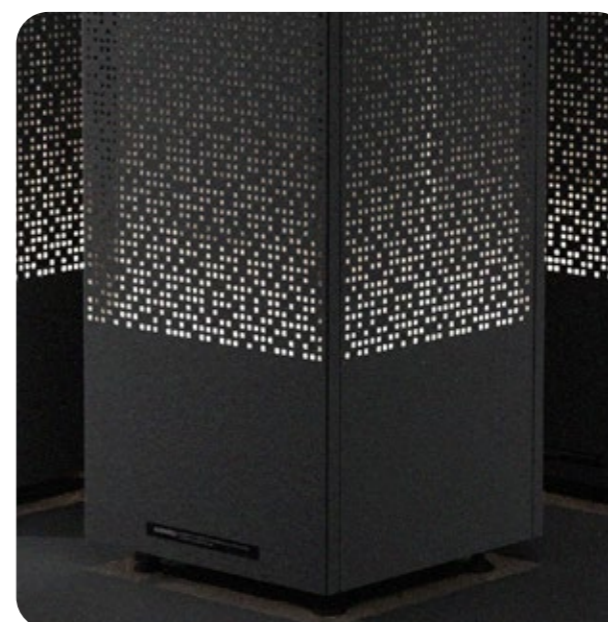
**BUILT-IN LIGHTS**

This is the first time a sauna heater has built-in lights.

**THERMOSAFE SURFACE**

The flocked ThermoSafe surface for safety; it never gets hotter than 40°C.



## For your comfort

Do you prefer a hot and dry traditional sauna or a more soft temperature with some humidity? Choose between our Traditional sauna heaters or our Combi heaters for a Soft Sauna experience and create your ultimate sauna experience. Available in black and gray as standard options.

### **DID YOU KNOW?**

The Combi version can achieve energy savings of up to 25% compared to traditional heaters by using temperatures of 65-70°C and a humidity of 35%.

# Under the hood

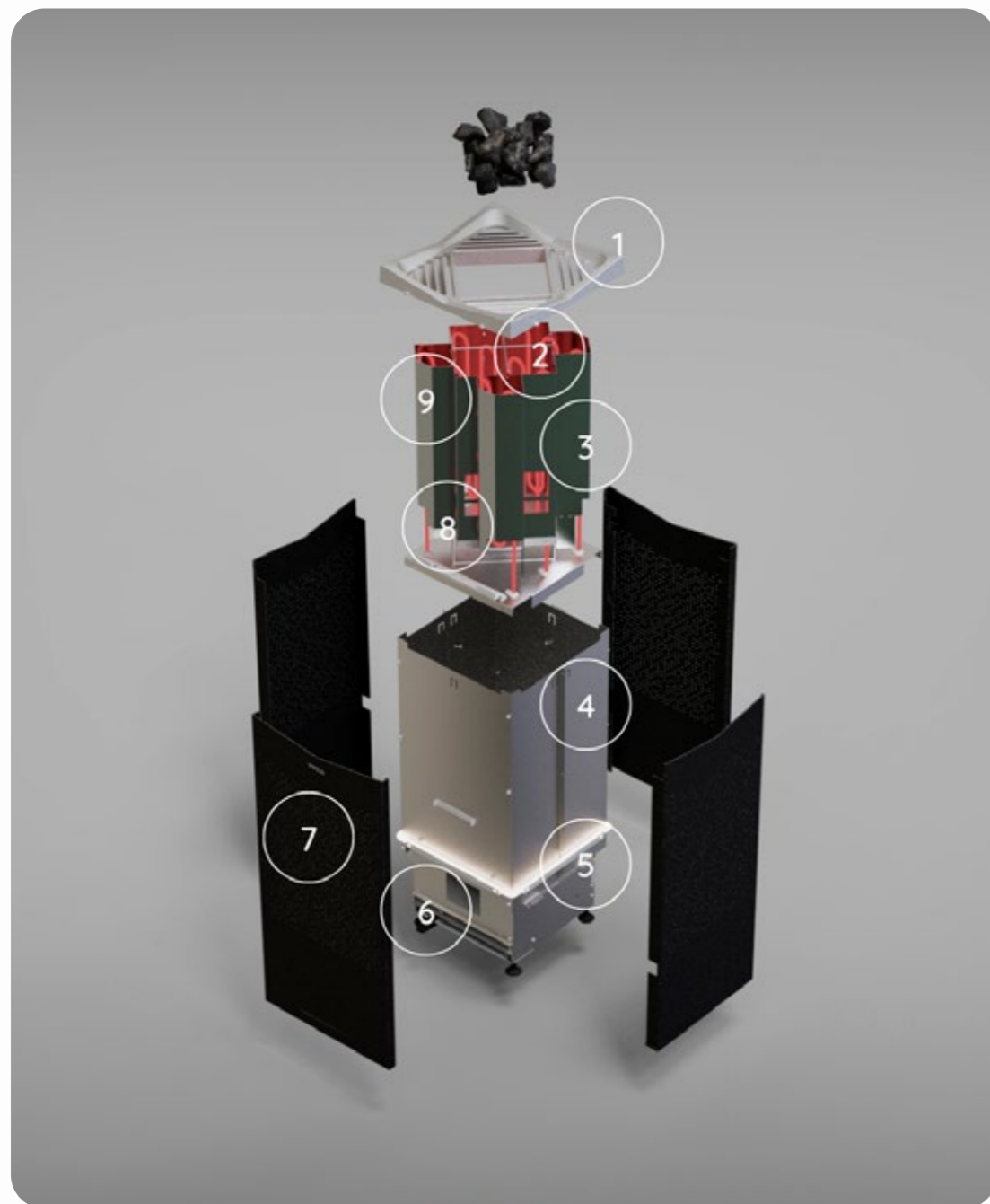

- |  |  |
|--|--|
| 1. Solid casted aluminum grill                     | 7. Changeable panels   |
| 2. TyLö quality heating element                    | 8. IntelliAir - Stones in the middle and 4 air chambers around |
| 3. Easier to change elements and store reservoir   | 9. Large and deep stone reservoir                              |
| 4. Inner cover for effective heat deflection       |  |
| 5. Sauna proof neon LED light                      |  |
| 6. Accessibility for easy installation and service |  |

# Product specification

## EASY TO PLACE

- Conveniently placed in a corner, against a wall, or in front of glass
- Features four equally beautiful and visible sides
- Floor standing

## FAST WARM UP

- Equipped with IntelliAir air chambers for efficient heating

## STONE RESERVOIR

- Enhanced capacity to hold a full pack of 20 kg of stones
- Deeper reservoir allows more time for the water to vaporize

## TECH

- Built in electronics – Elite control panel with Cloud-based functionality for maximum advantage and comfort
- Built-in lights

## INSTALLATION & MAINTENANCE

- Easily accessible without the need to turn the sauna heater to the back side

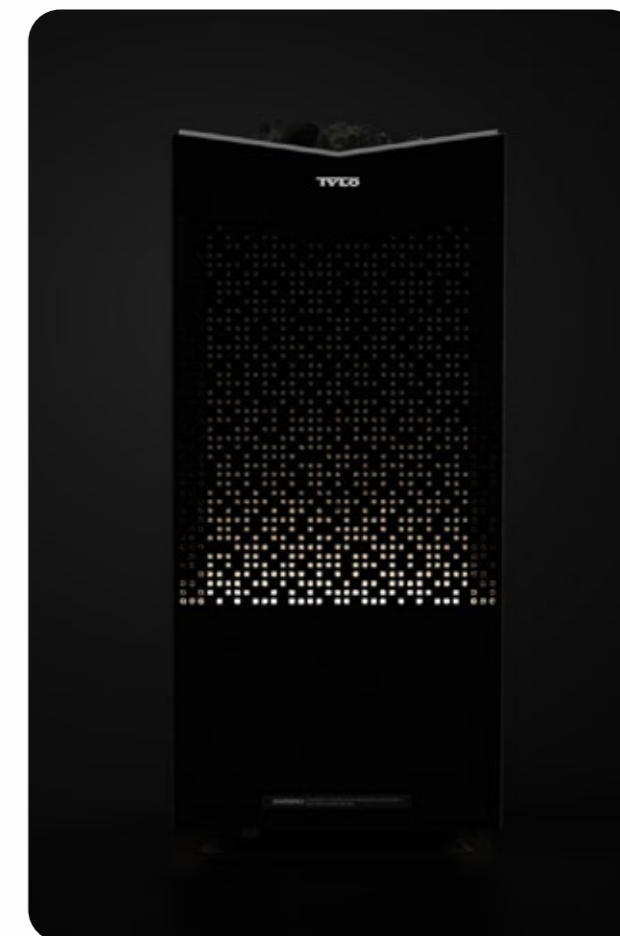

## YOUR DREAM SAUNA

At TyLö, we firmly believe in the boundless power of imagination. Is there a specific color or pattern that resonates with you? Beyond our standard options, we welcome the opportunity to fulfill custom requests. Reach out to a nearby TyLö dealer, and together, we can transform creative visions into reality.

# Choose your preferred sauna experience



## Traditional sauna

### THE AUTHENTIC SAUNA EXPERIENCE

Tylö Classic heaters provides a traditional and authentic sauna experience, offering high heat and low humidity. The heaters are designed to heat up the sauna quickly and efficiently, creating a hot and relaxing atmosphere.



## Soft Sauna

### THE TYLÖ SAUNA EXPERIENCE

Unlike traditional saunas, Soft Sauna gives you the luxury to choose your preferable balance between temperature and humidity. In practice, this means a gentler sauna session with a lower temperature, but with a much higher humidity (up to 70%).

# Traditional sauna heaters

Experience traditional sauna with Tylö Traditional heaters. These heaters provide an authentic sauna experience with high heat and low humidity, creating a hot and relaxing atmosphere. Designed to heat up quickly and efficiently, they make the perfect addition to any home!

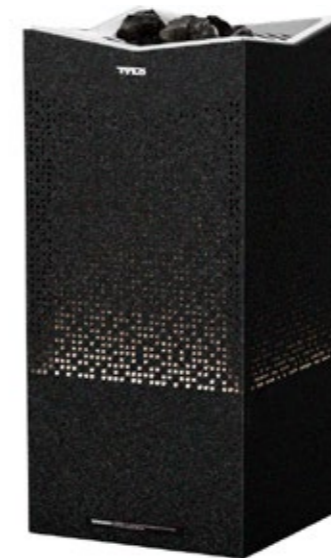

## CROWN

Floor-standing sauna heater with a symmetrical design, elegant lighting pattern, and a Crown-shaped grill for optimal airflow and rapid heat-up. Experience the full benefits of this heater's advanced technology, complete with the included Elite control panel for effortless operation.



## SENSE ELITE / PURE

**Sense Elite** has the Elite control panel, wifi connectivity for maximum advantage and comfort, included.  
**Sense Pure** is a heater that comes with the Pure control panel for ease of use and convenience. Door contact is required for delayed start.

### Choose either control panel to your Sense Elite/Pure heater



#### ELITE

Elite gives you an exact temperature control and also exact humidity control for the Crown and Sense models.



#### PURE

Comes with the standard digital touch control panel for ease of use and convenience. Let's you set temperature and time.

For more details about our control panels, see p. 62-63

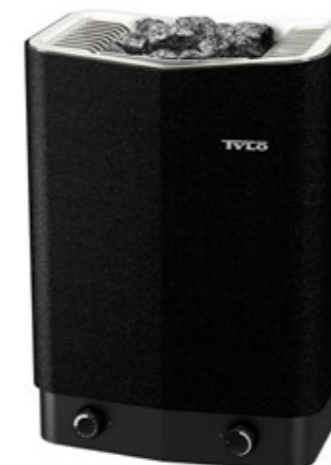

## SENSE SPORT

This heater is available in versions with two different power outputs and may be placed on the floor or on the wall. The control panel is built into the heater and located at its base.



## SENSE SPORT 2/4

This compact electric sauna heater has been designed to suit smaller scale sauna rooms without compromising style, quality and efficiency. Integrated control panel and Thermosafe protective coating allow for easy setting and improved safety.

# Combi sauna heaters

Experience Soft Sauna like never before with the Combi Sauna Heater! Customize temperature and humidity to your liking for a gentler, yet indulgent sauna session. Lower temperatures, higher humidity – the ultimate relaxation awaits!



## Did you know?

The Combi version can achieve energy savings of up to 25% compared to traditional heaters by utilizing temperatures of 65-70°C and a humidity level of 35%.



### CROWN COMBI

This sauna heater will add both substance and style to your sauna experience. Crown Combi is the perfect choice with its majestic design, crown-shaped grill, water tank for Soft Sauna experience, and stunning lighting pattern. This sauna heater will make you feel like sauna royalty. Use together with the Elite control panel.

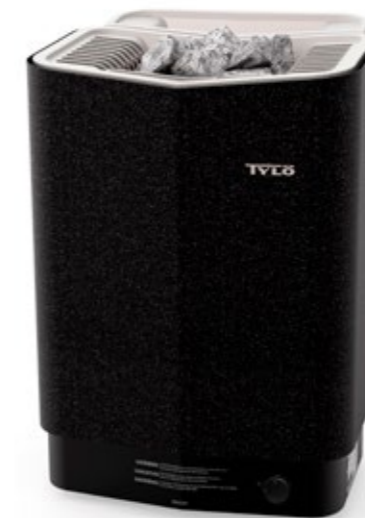

### SENSE COMBI ELITE/PURE

Same efficient and swift operation as the rest of the Sense heater lineup, but Sense Combi Pure/Elite delivers traditional dry sauna experiences along with ones including rich and enveloping steam, for an even higher level of versatility and pleasure. The Elite version comes with the Elite control panel with cloud connectivity.



### SENSE SPORT COMBI

Enjoy both sauna and steam functionality for a flexible sauna experience in a small package. The Sense Sport Combi 4 heater has an integrated control panel and Thermosafe protective coating for easy setting and improved safety.

Choose control panel Pure or Elite cloud on p. 63

## Control panels

Effortlessly manage your sauna using our intelligent control panels. The Pure model embodies simplicity and functionality, while the Elite version offers Cloud-based functionality and supports multiple user profiles

### Elite

#### EFFORTLESS BATHING

The new control panel Elite has been updated with Cloud-based functionality so you can control your sauna from anywhere! Why not have it ready when you come in from the ski slope or an exhausting car ride on the way home from work.

It is packed with advanced features, thanks to its internal processor and operating system. In addition to highly personalized settings, the Elite can be individually programmed according to your own schedule.

Add features such as auxiliary fans, fragrance pumps or lights - the Elite control panel handles it all with clear and concise precision. The 4.5-inch touch screen delivers real-time status on every aspect of your sauna and steam bath. Needs to be completed with a door contact for Cloud functionality.



### Pure

#### INTUITIVE DESIGN AND FEATURES

The elegant, compact design of the Pure control panel makes it the go-to choice for those who value functionality and simplicity. The thin black control lets you set the lighting, temperature and sauna time easily with only a few touches.

Of course, choosing the start time up to ten hours in advance means you can step into a wonderfully hot sauna or steam as soon as you get home. (Door contact needs to be added).

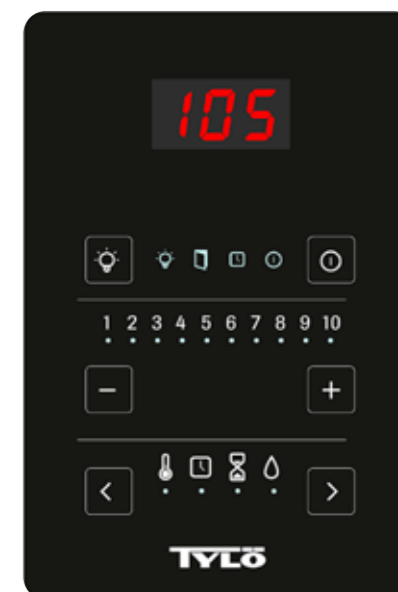

#### PLACEMENT OF THE CONTROL PANEL

We recommend to place it outside the sauna because of the lower temperature. You can place it in a Tylo Harmony room or a place built sauna if the ventilation is according to Tylo principle, the natural draught ventilation, and placed at least 300 mm from the heater and maximum height of 800 mm from the floor. If not, place it on the outside of the sauna.

The surrounding temperature shall not exceed 80°C / 176°F.



# Accessories



## High quality sauna stones

### TYLÖ SAUNA STONES

Genuine heat retaining vulcanite sauna stones from Tylö. Top quality sauna stones that are durable and provide excellent heat radiation. Place the stones loosely around the elements to shorten the sauna heating time and prolong the life of the heating elements.

## Brilliant silver

Bucket, ladle, hygrometer, thermometer, hourglass

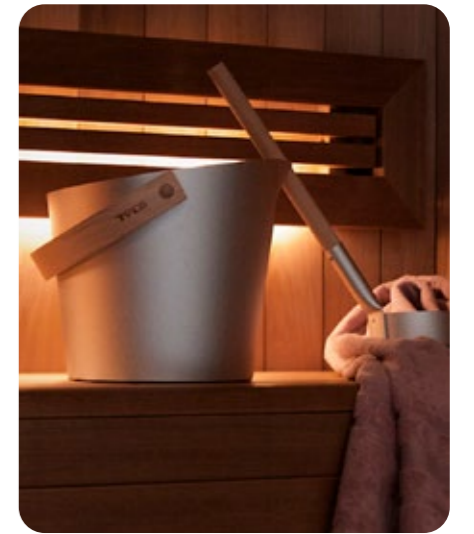

## Brilliant black

Bucket, ladle, hygrometer, thermometer, hourglass

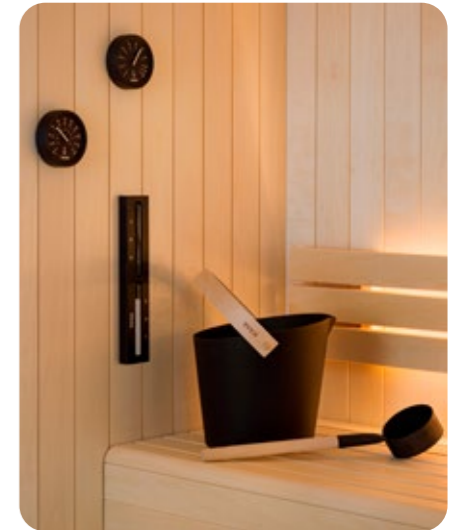

## Classic

### CLASSIC ACCESSORIES

Bucket, ladle, hygrometer/thermometer, thermometer.

### CLASSIC GIFT PACKAGE

Contains Classic bucket, ladle, hygrometer/thermometer and sauna fragrance.



## Heater stand

Black lacquered feet for Sense heaters 6, 8, 10 kW that are used when the heater is to be placed on the floor.



# STEAM

The heat, the water, the silence and the solitude, steam bath is the perfect way to relax and let the stressful demands of everyday life fade away. The steam room is our new place for free time, for reflection and for well-being. Schedule your steam sessions to be an integral and natural part of your everyday routine!

## 8 Benefits of steam

### 1. IMPROVED SKIN

The steam in a sauna helps to soften skin, unclog pores, and increase blood circulation, leading to healthy and glowing skin.

### 2. RELAXATION

The heat from a steam sauna helps to reduce stress and tension, leading to a more relaxed state of mind and better sleep.

### 3. RESPIRATORY HEALTH

Steam saunas can help relieve respiratory problems such as asthma and bronchitis as the steam helps to clear the nasal passages and open up airways.

### 4. IMPROVED MUSCLE RECOVERY

After a workout or strenuous activity, steam saunas can help to relax muscles, reduce inflammation and speed up muscle recovery.

### 5. DETOX

Steam saunas help in flushing out toxins, impurities, and excess water from the body through sweating, which helps in the detoxification process.

### 6. HEALTHY, RADIANT SKIN

Steam therapy enhances skin health, leading to a naturally glowing complexion. By opening up pores, increasing blood circulation, and aiding in the removal of impurities, steam helps the skin look vibrant and fresh.

### 7. STRESS REDUCTION

Steam therapy, whether through saunas or steam rooms, has been shown to lower the body's production of stress hormones, such as cortisol. As a result, spending time in a steam environment can promote relaxation and alleviate feelings of anxiety and stress.

### 8. IMMUNE SYSTEM BOOST

Regular use of steam saunas can help stimulate the immune system by increasing the production of white blood cells and activating the body's natural defense mechanisms. This can lead to better overall health and increased resistance to common illnesses.

# Steam showers

Tylö's steam showers are perfect in the modern bathroom and embody a distinct Scandinavian design.

## Vista

A sleek looking steam shower enclosure that symbolizes Scandinavian design. Vista has matt black, minimalistic profiles that can be with or without threshold, to give your bathroom that modern and luxurious look.

The glass walls are smoky grey for an extra graphic effect. The Vista enclosure comes with the Stella steam column in the same beautiful black. The enveloping steam starts in 2 minutes and soon you have a full, warm steam bath.



### ADVANCED CONTROL PANEL

You control your Vista steam shower with the advanced Elite control panel that blends perfectly into the black Stella column.

## Features



### RAIN SHOWER

Vista has a rain shower head in the ceiling and a high quality hand shower on the column for your preference.



### ENJOY THE FRAGRANCE THERAPY

The steam outlet is very silent and has a fragrance compartment on top so that you can enjoy the fragrance therapy

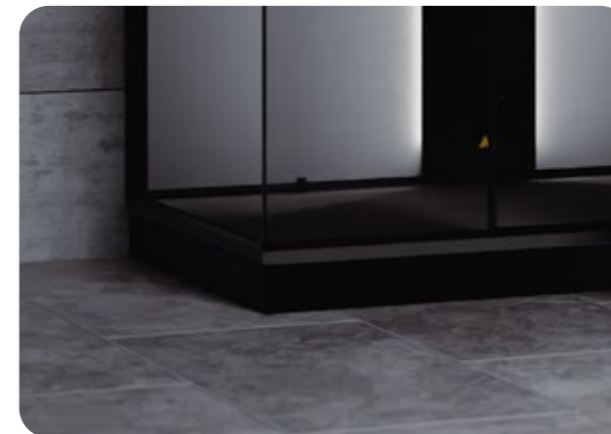

### VISTA TRAY

A minimalist shower tray in anthracite gray or white that fits with Vista steam shower. The tub has a non-slip coating to prevent slip accidents and comes with an anti-bacterial surface that makes it easy to clean. The tub can be mounted free-standing or be built-in.

STEAM SHOWERS

# Stella

The enveloping steam starts in 2 minutes and soon you have a full, warm steam bath. You control your steam column with the advanced Elite Cloud control panel that blends in perfectly with the black Stella front. The glass front is wider than the column, to give it a floating, nice look. Behind the glass are the LED lists. The hand shower, thermostat and mixer are of high quality and luxury

material. The steam outlet is very silent. Like the Vista, it has a fragrance compartment to enjoy the fragrance therapy of your choice. A ceiling shower head can be connected and controlled from the column. To match the black, sleek look you can add the matching stool and shelf in black aluminium.

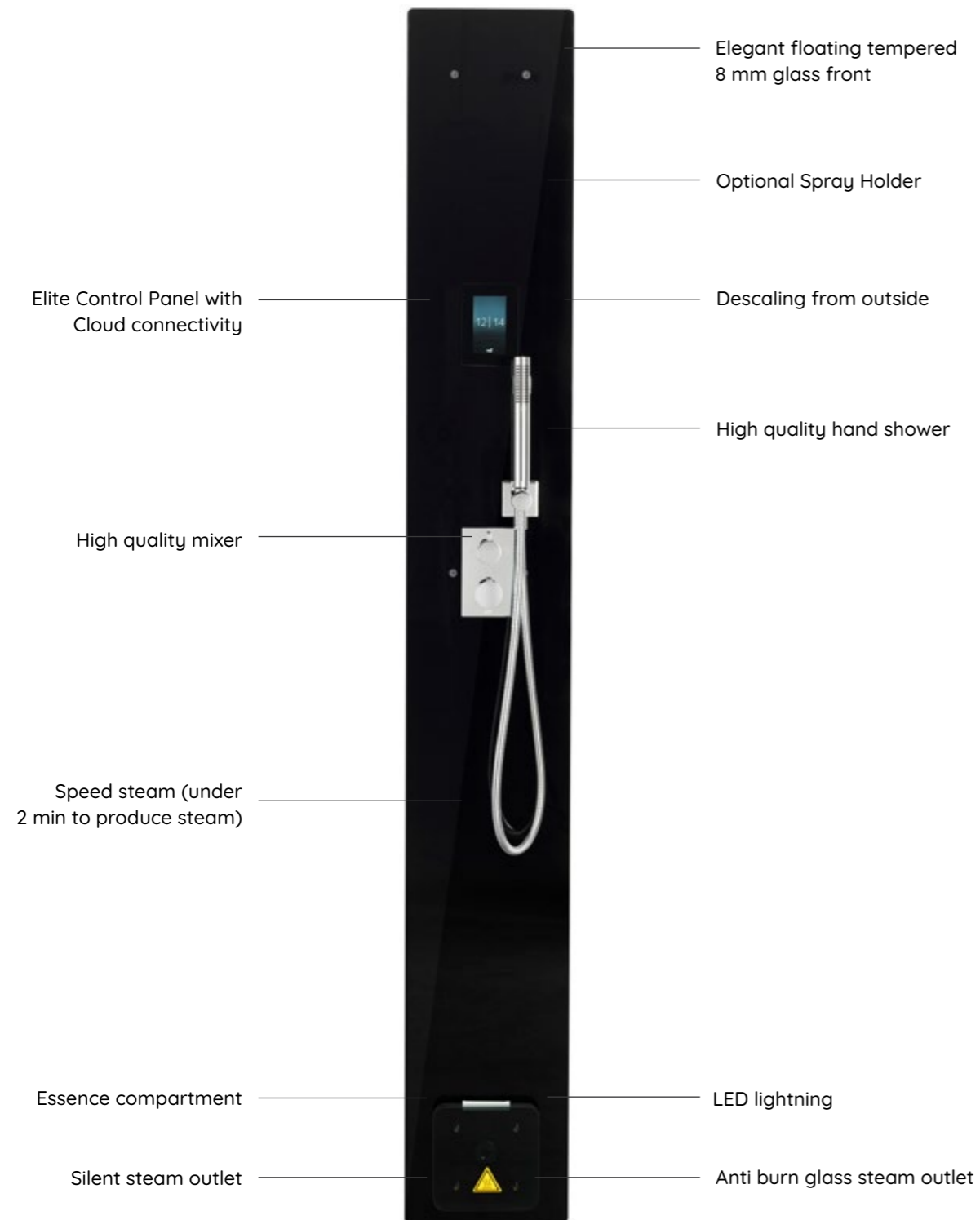

Build your own at home steam bath with this modern steam column of true Scandinavian design. The black glass front and the option of chrome, brushed brass or matt black coloured details makes it easy to fit in any tiled shower space

OPTIONAL DESIGN



# Steam rooms

## Panacea

The Panacea steam bath soothes both body and soul. The hot steam envelops the body, releasing tension and easing muscle aches, while a variety of light settings provide relaxing additions to the mind. Panacea is available in several different standard sizes and comes with a dramatic back-lit wall.

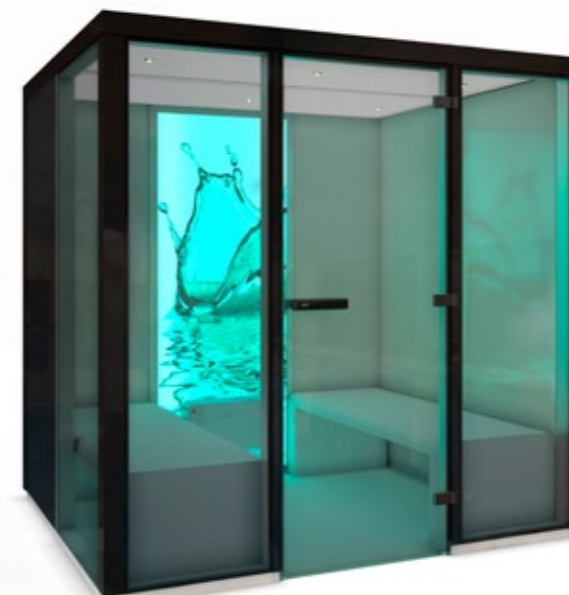

### RGB LIGHTS

As an option to make it more personal, you can add the RGB lights that are placed in the back wall and has a declining gradient that meets the lights coming from the steam column. For additional lights in the ceiling, spotlights are sold separately.



### CORIAN BENCH

Hardwearing and hygienic bench for larger steam rooms.

#### BENCH 1545

Size: W 1545 x D 600 x H 450 mm

#### BENCH 1945

Size: W 1945 x D 600 x H 450 mm

#### BENCH 2345

Size: W 2345 x D 600 x D 450 mm

Find drawings on page 120-121

# Customized steam rooms



## 4 good things to know when building a steam room

### 1. MAKE SURE YOUR GENERATOR IS POWERFUL ENOUGH FOR THE SIZE OF YOUR STEAM ROOM

Choose a powerful steam generator based on your room size. We offer smart versions for both home and commercial use.

### 2. PRIORITIZE PROPER DRAINAGE FOR YOUR STEAM ROOM

Ensure proper drainage for your steam room. Place the generator near a drain for easy water disposal. Commercial use requires the optional automatic drain function.

### 3. PREDETERMINE THE FREQUENCY OF MAINTENANCE

Test your mains water hardness to determine maintenance frequency.

### 4. REGULAR MAINTENANCE FOR COMMERCIAL STEAM ROOMS

Commercial users may need to manually descale and clean the generator regularly. Daily flushing is necessary in commercial settings.

# Doors & glass sections

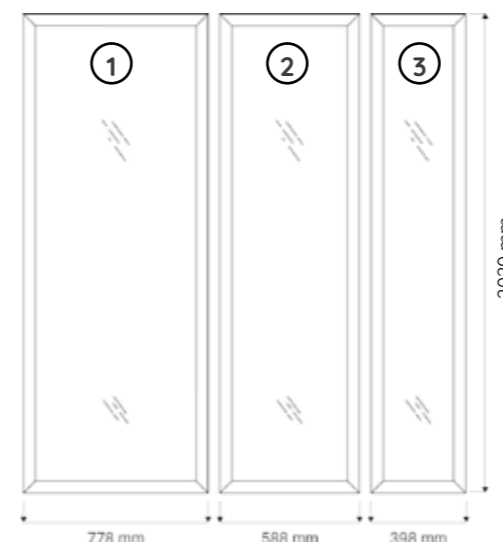

You can achieve your desired width by combining a steam door with your choice of glass sections. Standard for glass section is 60 G profiles

- 1. GLASS SECTION 778/2020 BRONZE** Size: 778 x 2020 mm.
- 2. GLASS SECTION 588/2020 BRONZE** Size: 588 x 2020 mm.
- 3. GLASS SECTION 398/2020 BRONZE** Size: 398 x 2020 mm.

### GLASSFRONT VISTA

Customize your glass-fronted steam bath VISTA according to your needs. The glass front is available up to dimensions 2400x2500mm. The glass is smoke gray for an extra graphic effect. The front has a frame of matt black aluminum profiles. Even the hinge and handle/knob are in matching matt black aluminium. The front is available with or without a threshold.



**1. STEAM DOOR 101 G**  
Glass steam room door with wheelchair access, no threshold, and wide opening. Available in bronze tinted tempered safety glass, mounted on four hinges for extra strength.



**2. STEAM DOOR 60 G**  
Glass steam room door with magnetic strip closure, available in clear or bronze tinted tempered safety glass. Clean look with aluminum door surround, suitable for left or right-handed installation.



**3. STEAM DOOR 50 G**  
Compact glass steam room door with magnetic strip closure. Tempered clear glass and hidden hinges for a tidy look. Aluminum door surround includes a bottom runoff strip.



**4. STEAM DOOR**  
Professional-grade steam room door designed for high-traffic public steam rooms. Available in clear or bronze tinted safety glass with thresholdless construction for wheelchair access. Matches DGL/DGB range design for sauna proximity.

# Steam column

The Steam Shower column Stella, clad in 8 mm black tempered glass with LED lighting, offers swift steam production in 2 minutes. It features an integrated Elite Cloud control panel, a safe and stylish smoke-colored glass steam nozzle with fragrance bowl, and the option to connect a rain shower.



**STELLA STEAM COLUMN**  
More information on page 70.

# Steam generators & accessories



**STEAM HOME 3/6/9 kW**  
Our latest compact and effective steam generator for home environments. It offers new and improved features such as stand-by, an aromatherapy option and improved protection against stoppages.



**FRAGRANCE PUMP**  
Available as an option for your steam generator and connects simply to the outlet pipe. Add any 5-litre concentrated fragrance.



**WATER SOFTENER**  
Effectively reduces water hardness to 1° dH, enhancing reliability and lifespan of steam generators. This automatic unit eliminates the need for manual control or electric timers. By eliminating calcium, it minimizes steam generator descaling, prolonging their lifespan. No electrical connection required, just connect to water supply and drainage for backwash. Ideal for Steam Commercial and Steam Home systems. Utilizes salt blocks requiring periodic refills.



**BAHIA HOME**  
The Bahia steam outlet is the obvious choice for form, function and aesthetics. Tempered safety glass design with Corian or high-gloss plastic. Tempered safety glass and high-gloss plastic. Size: W: 280 mm H: 180 mm.

Looking for Commercial products? Go to page 92.



# Accessories

For the Vista experience, add the matching accessories; stools and shelf in matt black aluminum. Or, if you prefer, you can also choose the white Corian stools.



## PIXEL STOOL

This stool can be used both inside your Vista steam enclosure or as a nice-looking stool in your bathroom. It is made of aluminium and in a softly bended shape, so it is comfortable to sit on. The smooth surface is covered in a beautiful matt black powder coating to match the profiles on the Vista. Available in sizes:  
W 660 x D 310 x H 450 mm  
W 350 x D 320 x H 420 mm



## PIXEL SHELF

A small shelf for your shower products or just as a nice decoration. It has the same matt black colour as the profiles on the Vista steam shower enclosure. It can hold up to two kilos and the pattern of the pixels is cut so the water doesn't stay on the shelf. Size: D: 90 L: 400 mm



## STOOL CORIAN

Ergonomic and easily portable stool made out of the hygienic and luxurious material Corian. Available in sizes:  
W 660 x D 310 x H 450 mm  
W 350 x D 320 x H 420 mm

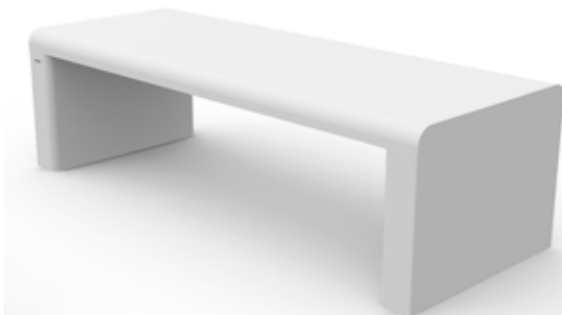

## CORIAN BENCH

Hardwearing and hygienic bench for larger steam rooms, made out of the luxurious and hygienic material Corian.

Available in sizes:  
W 1545 x D 600 x L 1545 mm  
W 1945 x D 600 x L 1945 mm  
W 2345 x D 600 x L 2345 mm



INFRARED

## 6 Benefits of using an infrared sauna

### 1. DETOX

Infrared saunas are effective in detoxifying the body through the elimination of toxins, chemicals, and heavy metals through sweat.

### 2. REDUCED PAIN AND INFLAMMATION

Infrared saunas help to relieve pain and inflammation caused by conditions such as rheumatoid arthritis, fibromyalgia, and osteoarthritis.

### 3. BLOOD PRESSURE

Infrared saunas can help to improve blood circulation, lower blood pressure, and improve overall cardiovascular health.

### 4. STRESS RELIEF

Infrared saunas can help to reduce stress and improve mental well-being by promoting relaxation and reducing cortisol levels in the body.

### 5. BOOSTED IMMUNE SYSTEM

Regular use of infrared saunas can help to stimulate the immune system, reduce the risk of infections, and improve overall health and well-being.

### 6. SAFE TO USE

Infrared saunas are safe for people of all ages and have no side effects when used appropriately, making them a convenient option for those who seek a natural approach to healing and relaxation.

# Choosing your infrared sauna is as easy as 1,2,3

1. **ONE-PERSON ROOM** Indulge in ultimate relaxation in your private sanctuary.
2. **TWO-PERSON ROOM** Share the warmth with a loved one or a friend for a cozy experience.
3. **THREE-PERSON ROOM** Embrace family time while enjoying spacious infrared heat.

All our infrared rooms come in stylish black and grey and offer ample space for your comfort. Can't decide? Explore our Combi Room on pages 90-91 for the best of both worlds - infrared and traditional sauna experience combined!

Experience the many benefits of our infrared rooms with cutting-edge features, including low EMR emissions for safety, an elegant all-glass front wall, customizable RGBW light control with dimmer for the perfect ambiance, soothing valance lights, and therapeutic color light therapy. Indulge in a holistic wellness journey like never before!



### ONE-PERSON ROOM

The perfect room if you're short of space or just want to sauna alone.  
Dimensions: W 913 x D 913 x H 1938 mm



### TWO-PERSON ROOM

This popular room is perfect for up to two people.  
Dimensions: W 1213 x D 1013 x H 1938 mm



### THREE-PERSON ROOM

A combination of great design and superb space efficiency, this room comes with a 5-sided design. Ideal for up to three people and fits into almost any corner.  
Dimensions: W 1301 x D 1301 x H 1938 mm



### THREE-PERSON ROOM

This roomy, elegant infrared room is for up to three people.  
Dimensions: W 1633 x D 1078 x H 1938 mm

# Features for extra comfort and style

Tylö's infrared sauna comes with a variety of top-class standard features and offers an array of colour treatments. Come out feeling stronger, healthier and in better balance!



**HANDLE**  
Handle that doubles as a towel rack on the outside and a tablet holder on the inside.



**FLOOR**  
The CarbonFlex floor plate with infrared heat in colours that match the panels.



**LIGHTING**  
Indirect lighting for the best relaxation. RGBW for colour choices.



**SPEAKERS**  
Bluetooth audio



**SEATS**  
Rounded seats for added comfort and legroom.



**PANEL COLOUR**  
All models are available in grey or black cloth to match your room's ambiance.



## Smart, intuitive control panel

Lean back with your favourite playlist, relax to your latest audiobook story, or change ceiling colours with just a touch.

- Wi-Fi capability
- Mobile app available
- Intuitive display (time/temp/lighting/system status).
- 60-minute timer.
- Built-in RGBW light control with Dimmer.
- Built-in Bluetooth audio.
- Voice control compliant with Alexa, Google and Siri.



INFRARED SAUNA

# Enjoy therapy through colours

We all know we need light to live. Especially in the dark winter months. Chromotherapy is about using colours to enhance our health and well-being, with each colour in the spectrum having a different, positive effect on our bodies. Which is your favourite?



**ENERGY**  
The symbol of love and passion. Increases energy and vitality.



**RELAX**  
Green is harmonic and relaxing, supports balance and love.



**CALM**  
Blue increases calmness, the color stands for peace and kindness.



**CREATIVE**  
Turquoise helps us become more peaceful, serene and creative.



**HAPPY**  
Yellow is the color of happiness and high energy, it increases humor and lightness.



**AWARENESS**  
Violet is the color of spiritual awareness, it stimulates intuition and imagination.



Infrared sauna

## Tylö's infrared sauna Tylösand consumes only about 1.5-2 kWh for one hour of use, making it a highly energy-efficient choice

Along with the many health benefits of an infrared sauna, the energy efficiency is another incentive. Infrared technology uses less electricity than many other common household appliances.

Compared to a traditional sauna, the function of infrared is not to heat the air, but rather heat the organic material, your body, in the room. And since you don't wait for an infrared sauna to heat up, you can enjoy its benefits immediately!

Traditional sauna is normally used in temperatures between 65-90°C with an average sauna bath of 1 hour. A smaller sauna room usually consumes about 4 - 5 kWh, depending on size, construction and desired temperature. Tylö's infrared room needs approx. 1.5 - 2 kWh for 1 hour of use in comparison.



## Combination 2 in 1 sauna

Not sure what type of sauna you want? Why not have both? Incorporate our infrared panels into your sauna space, allowing you the flexibility to enjoy a traditional sauna bath or opt for the gentle heat therapy of the infrared panels.

### HAVE UNUSED SPACE THAT NEEDS A PURPOSE?

Craft your personal infrared room! Utilize our varying sizes of infrared panels to fashion the ideal infrared space that suits your needs. Our advanced traditional Tylo sauna system has been seamlessly combined with infrared technology to give you the best of heat.

### THREE DIFFERENT KINDS

Choose from three different kinds of loose infrared panels that you can swap for part of the backrest, offering double the amount of sauna joy. Panels available in grey and black. The fabric panels are made from hemlock and come in three sizes to fit your space. Combine them in your sauna or use them to build a custom-fitted infrared room.



Learn about various uses of infrared panels by scanning the QR code!

## More effect, less energy

Infrared saunas use heat waves to heat up your body directly, so you need less heat to get a more intense sweat.

### FULL BODY WARMING

Tylo's infrared saunas use exclusive infrared panels that give you the same heat from bottom to top, evenly spread over your body. The panels have a larger heating surface to give you the best in comfort. They spread heat over a wider area to give you the most comfortable surface temperature. They also transmit maximum exposure over the widest possible area to create optimal infrared wavelengths that give you soft, even heat for that perfect sauna experience. And they're probably the safest panels on the market, using our own patented technology.



Power (kW) 100  
W 275 x D 37 x H 980 mm

Power (kW) 150  
W 360 x D 37 x H 980 mm

Power (kW) 300  
W 680 x D 37 x H 980 mm

With our infrared panels, you can set up your infrared room so that you receive warmth on your back, calves, and/or sides.

# COMMERCIAL



## Your complete partner for commercial sauna projects

Tylö is a trusted partner when it comes to commercial sauna projects, with a presence on all continents. Whether you're looking for a traditional sauna, steam room, or infrared warmth, Tylö has you covered. With a commitment to providing high-quality sauna experiences, Tylö is your complete sauna solution that adds value to your business.

# Commercial sauna heaters



## SENSE COMMERCIAL

The smaller Sense Commercial sauna heater is available with two different power outputs. Combine with the Elite Cloud control panel and you can control it from anywhere!

The larger one in three different outputs is suitable for larger commercial or public saunas. Can be complemented with a steam generator, a steam distributor, a relay box and Elite Cloud control panel to be turned into a complete Tylarium experience.



## Sense Commercial + Steam Commercial = Tylarium

Combining the Steam Commercial generator, Sense Commercial sauna heater with steam distributor, and the Elite\* control panel makes a Soft Sauna experience possible in public and commercial spaces as well. Representing a new way of enjoying heat and humidity, Soft Sauna is a modern take on the traditional sauna.

Control and monitor your sauna from the office or reception using nothing but Wi-Fi, a mobile device and Tylö's app. The app was specially developed to optimize your sauna experience and is compatible with iOS, Android and desktop PCs.



Steam Commercial generator



Sense Commercial sauna heater with steam distributor



Elite control panel with relay box Commercial and Tylarium Elite Kit\*



Calculate how much you can save with our Standby tool. Scan the QR code.

\*Temperature/humidity sensor, 4 meter sensor cable, 3 meter Sync cable



## Steam generators

Our durable steam generators work reliably even when used continuously, with minimal maintenance and service costs. They are equipped with several convenient features for the best experience.



### STEAM COMMERCIAL

Our Steam Commercial steam generator is equipped with a large water tank and is designed to easily connect to our Multi-Steam function – an effective way to avoid stoppages in frequently used systems. Available in 9 / 12 / 15 kW effect



### STEAM OUTLET PRO

Bahia PRO is created for commercial use. Crafted from hardened safety glass with Corian, this steam outlet ensures even steam distribution and minimal noise levels. Perfectly designed for public facilities. Simply mount on a flat wall section. Elevate your steam experience with Bahia Pro.

## Choose your control panel for your generator



### ELITE

Lets you set the exact temperature for full control. Weekly program and other useful settings for Commercial use. Cloud connectivity for maximum advantage and comfort is included



### PURE

Comes with the standard digital touch control panel for ease of use and convenience. Let's you set temperature and time.

## Customised steam room

Tylö offers steam generators for commercial use for a premium steam experience in your establishment. Customize your steam room to your exact specifications and provide your guests with the ultimate relaxation experience.



# Panacea Twin

## A seamless solution with sauna and steam in one.

Panacea Twin offers both steam bath and sauna room in a seamless Scandinavian design making it the perfect solution for any commercial environment. The two-in-one sauna room is available in standard sizes with everything included, as a package deal, where design flows unrestrained. It's easy to install and remove if your operations is in a rented facility.

See sizes on page 121.

# Energy consumption and sauna bathing



## Are you saving with standby?

Tylö commercial saunas come with a standby function that drops the temperature when not in use. This allows guests to easily heat the sauna to their desired temperature by simply pressing the start button or external switch when they are ready to use it. Our sauna's standby function not only provides convenience for guests to quickly heat the sauna to their desired temperature but also helps to save energy by reducing the temperature when not in use. This energy-saving feature helps to reduce electricity bills and minimize environmental impacts.

### EXAMPLE

A Sense Commercial 16 sauna, operating 14 hours a day, 365 days a year in a 28m<sup>3</sup> space, and with an average daily standby duration of 3 hours, can result in annual savings of 1524€. This calculation is based on an electricity cost of 0,25€/kWh.

**You are just a few short questions away from learning how standby mode can result in savings for your commercial sauna and steam project.**



Scan the QR-code and answer the questions to see how much you can save. Or go to: [tylo.com/energy-saving-calculator](https://tylo.com/energy-saving-calculator)

CASE

# Skepparholmen Nacka



The market for the popular infrared sauna continues to grow explosively and is becoming an increasingly common feature of modern spas. As a step in developing its experience, Skepparholmen Nacka has now supplemented its experience with an Infrared sauna from Tylö.

At the spa and meeting hotel Skepparholmen Nacka, guests are greeted by an experience that stimulates all the senses. Beautifully located in Stockholm's inner archipelago and overlooking the Salt Lake, Skepparholmen's spa guests can sit back and be captivated by the natural surroundings.

When the discussion about a possible renovation began, the goal was to find a complement to the hotel's existing spa experience, and not least a renewed experience for the guests. Jenny Strömberg is spa manager at Skepparholmen Nacka and she too had noticed the high demand for IR saunas:

**“Our ambition was to complement our spa with something new and caring for our guests.”**

We want to develop and innovate the spa experience, and have noticed that infrared saunas have become very popular. Our ambition was to complement our spa with something new and caring for our guests. It's really fun to see that our newly installed IR sauna has become appreciated among our guests”



With the hotel's close-to-nature experience in mind, Tylö created a tranquil and embracing environment where the contrasts in the material choices symbolize true to nature and modern design. The result was black taika panels combined with a slim interior in alder.

“The interior is made of Tylö slim in alder with decorative grids in Tylö classic. This creates more life in the space and match the IR panels on the walls,” says Wilhelmina Fernebrand, project sales at Tylö.

As the IR panels heat the body from the inside, the heat from the panels is supplemented with a heater that keeps the room at a constant temperature of 45 degrees. Something that is necessary in larger rooms to improve the overall experience!

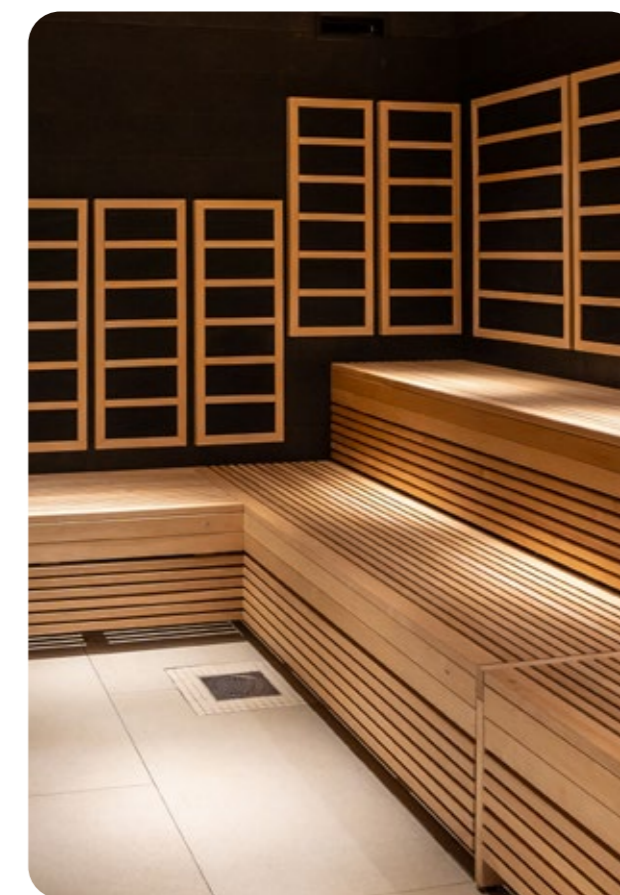

## What is the difference between an IR sauna and a traditional sauna?

An infrared sauna uses light of infrared wavelengths to heat the body. The IR sauna thus heats the person in the sauna, rather than the surrounding air as in a traditional sauna. This means that the infrared sauna is perceived as cooler and milder than a traditional sauna, and is a good alternative for those who find the traditional sauna too hot. The infrared sauna results in the same relaxation and sweating as the traditional sauna, and in addition with a range of health benefits such as pain relief, improved blood circulation, strengthened immune system and improved sleep.

## CASE

# Pater Noster

On one of Sweden's most windblown, barren and exposed places, Pater Noster invites to an authentic experience in a beautiful setting. Enjoy a meditative moment in the heat of the sauna while gazing out across the spectacular lighthouse and stormy seas. Tylö's driftwood panels harmonizes perfectly with the spectacular surroundings on this beautiful island in the outpost of the archipelago.

**FUN FACT**

Each nominee for the 2023 Oscars received a gift that among other things included a luxurious stay at the Pater Noster hotel, located just outside Marstrand, Sweden.





CASE

# Asia spa

With a serene approach and creative ingenuity, the stunning Asia Spa in Varberg, Sweden has fashioned a captivating rooftop sauna offering enchanting ocean vistas. This harmonious blend of imaginative design and tranquility has yielded truly exceptional results.



## EXQUISITE SLIM SAUNA BENCHES IN THERMO ALDER

These slim benches boast a soft, rounded corner and are adorned with vertical panels, all expertly crafted from Thermo Alder wood. With the stunning view and a warm and cosy sauna aesthetic, Asia Spa really does have an amazing sauna worth a visit.

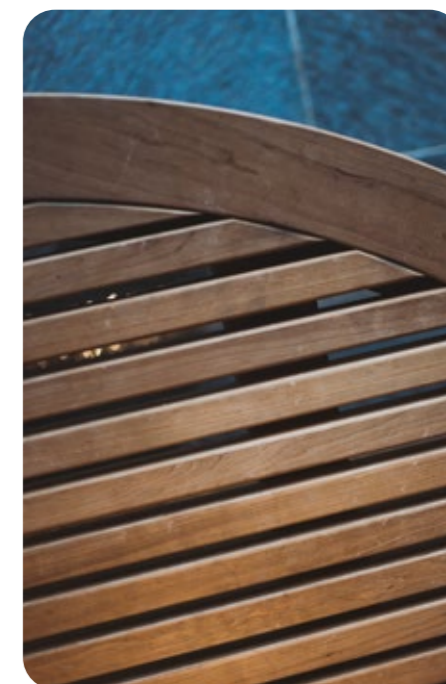

## COMFORT WITH WIDE THERMO ALDER BENCHES

Asia Spa chose Wide Thermo Alder sauna benches for their other sauna, meticulously designed for relaxation. The extra space invites you to fully unwind, while the warm and inviting Thermo Alder wood adds a touch of natural luxury to the environment.

On the beautiful west coast in Sweden you will find Varberg Coast Hotel. The magnificent buildings and the enchanting landscape create a stunning environment. In 1992 the hotel became Varbergs Kurort that today are Varberg Coast Hotel. They refine the spa traditions that have existed locally in Varberg for over 200 years. Varberg is known for their unique spa and sea environment.

The Thalasso spa it is the only one in Sweden and it offers well-being close to the sea and has classic treatments like seaweed baths, cold baths, sauna baths and massage. It is all based on a long spa tradition.

In the Paus sauna you can enjoy a lower temperature that is more comfortable. This is good for you who prefer a combination of heat and humidity or to use as a warm room between the hot sauna sessions. The heater is a TyLö Sense Commercial which has an extreme fast heat up time and reduces power output once set temperature is reached. It is perfect for provide soft sauna steam.



CASE

# Varberg Coast Hotel



CASE

# Calmar City Hotel

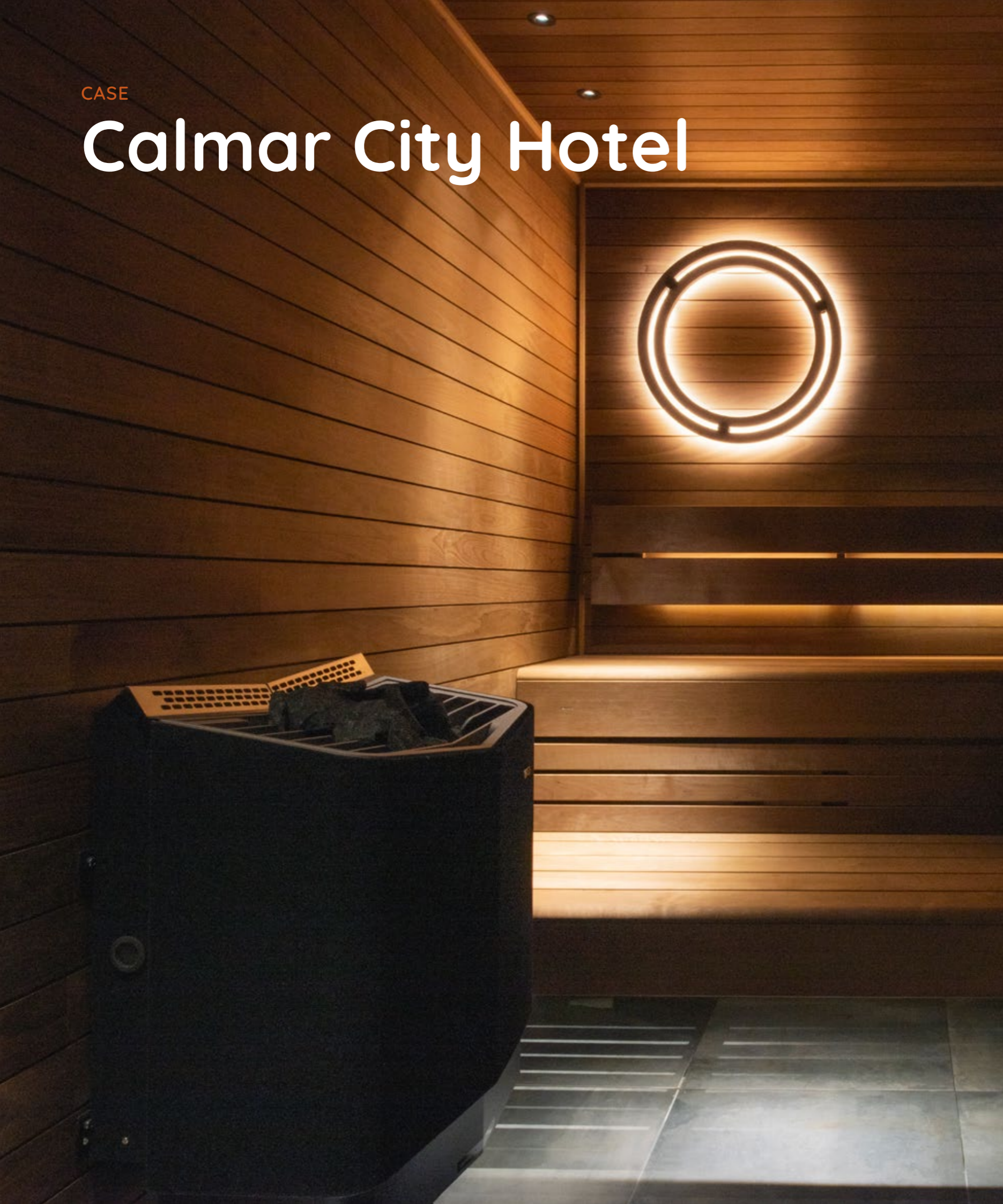

This beautiful sauna boasts a unique combination of materials and lighting that create a sleek and modern ambiance. Thermo aspen, a high-quality and sustainable wood, is seamlessly integrated into the design of the hotel, creating a warm and cozy feel throughout.

The interior is cleverly crafted, featuring slim thermo alder wood that brings a lightness to the overall appearance of the space. But it's the creative and inventive lighting solutions that make this hotel truly stand out. The lighting design illuminates the space in a way that sets the perfect mood.

From the warm and welcoming glow in the hotel lobby to the intimate lighting in the guest rooms, everything has been thoughtfully and expertly designed. Whether for a business or leisure trip, guests will feel at home in this city hotel. Not only is it aesthetically pleasing, but the high-quality materials and attention to detail ensure that visitors will enjoy a comfortable and luxurious experience. From the lobby to the guest rooms, every inch of this hotel is designed to create a sense of relaxation and well-being.







## CASE

# Hotel Tylösand

Hotel Tylösand on the coast of south-west Sweden is one of the country's leading spa hotels. Famous for active leisure and recreation, the hotel offers a unique approach to health and fitness.

Its new initiative is biohacking featuring IR treatment, laser treatments and led masks. They chose Tylö's infrared rooms for IR treatments.

Hotel Tylösand now features cutting-edge infrared (IR) treatments as part of its wellness offerings. The incorporation of IR therapy aligns with the hotel's biohack concept, catering to both recovery and well-being. Unlike its previous use for rehabilitation, IR therapy here serves a dual purpose. This choice reflects the therapy's popularity and synergy with the biohack philosophy, establishing the hotel as a Swedish pioneer in IR treatments. This step highlights the hotel's dedication to providing top-notch experiences for guests.

## HOW DOES IT WORK, AND WHAT ARE THE BENEFITS?

Hotel Tylösand simplifies the process. Guests can choose between 25-minute and 50-minute IR treatments, available for guests seeking infrared (IR) therapy. For an added detoxification, a special detox tea is offered.

Infrared saunas, as explained by the experts at Hotel Tylösand, offer dual benefits for our inner and outer well-being. An effective skin cleanser, they also aid relaxation and, in some cases, lead to improved sleep quality. These treatments are especially beneficial after a workout, aiding muscle recovery.

## WONDERING ABOUT THE RIGHT TIME FOR AN INFRA TREATMENT?

According to the hotel's perspective, IR treatments are suitable after sports activities or whenever relaxation is desired. The trend of using IR as a recovery tool after sports like padel, crossfit, tennis, and football has been observed. Additionally, people of all age groups opt for IR treatment, not only for recovery but also as a form of beauty therapy.

**Hotel Tylösand chose infrared sauna as treatment as it is a part of the biohack concept and its widespread popularity**

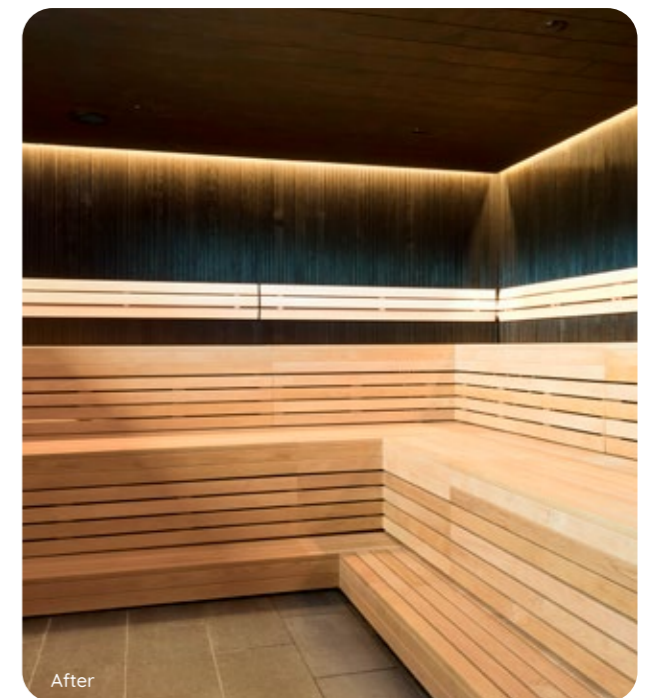
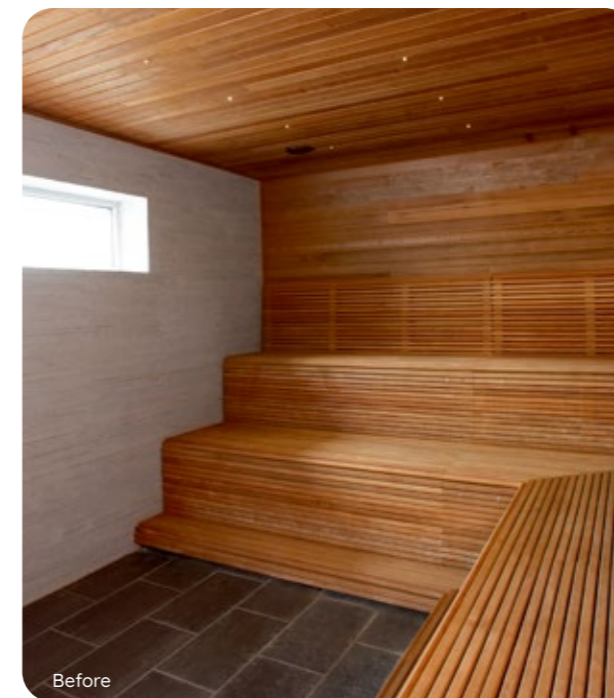

During the renovation of one of their saunas, Hotel Tylösand conceived a space with black walls and ceilings adorned with integrated lighting to create a warm and inviting ambiance. The outcome of this initiative proved to be truly remarkable.

# Do you prefer hot & dry or with a gentle steam?

## TRADITIONAL SAUNA

Scandinavian sauna, according to tradition, comes in two varieties. The most classic version is where the temperature is somewhere around 75-90° C, and with a humidity of around 5-15%. Every now and then, a scoop of water is poured on the stove, spreading a comfortable and steamy heat in the sauna room. A more extreme version is the way many Finns like to do it, with a very high temperature (approx. 95-110° C) and almost no humidity.

## TYLÖ SOFT SAUNA

Soft Sauna is a milder version of sauna and stays at a temperature of around 45-65° C. This temperature in combination with a very high humidity of around 30-65%, provides for a mild and soft sauna experience suitable for adults as well as children. To enhance the experience, you can also add natural herbs or aromatic oils to the steam.

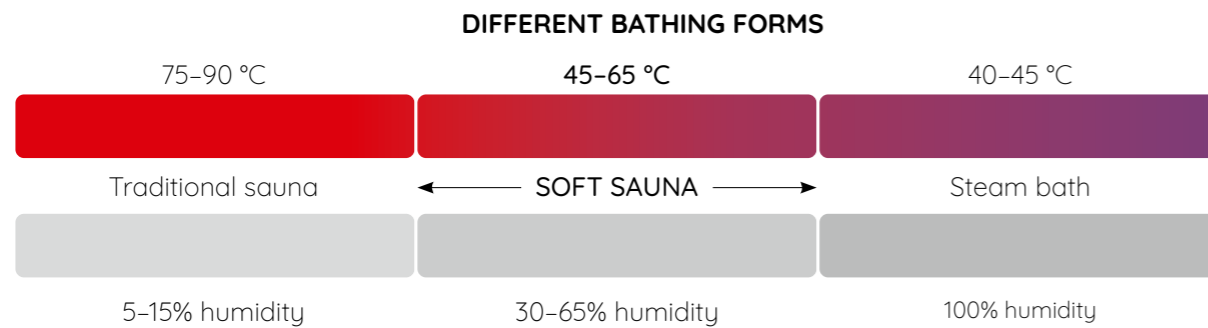

# Home use

## HOME ELECTRIC SAUNA HEATERS

Product	Output (kW)	Sauna volume (m³)	Weight heater + rocks (kg)	Size (WxHxD)	Safety distance				Suitable control panel	Installation
					Side (mm)	Front (mm)	Ceiling (mm)	Floor (mm)		
Crown Combi Elite 6	6,6	4-8	29+20	360x360x800	50	30	1900		Elite included	Floor standing
Crown Combi Elite 8	8	6-12	29+20	360x360x800	50	30	1900		Elite included	Floor standing
Crown Combi Elite 10	10.5	10-18	29+20	360x360x800	50	30	1900		Elite included	Floor standing
Sense Sport Combi 4	4,5	2-4	13,4+7	348x480x274	20	30	1900	100	Built-in	Wall mounted
Sense Combi Pure 6	6,6	4-8	23+20	435x625x375	110	30	1900	100	Pure included	Wall mounted or floor standing*
Sense Combi Pure 8	8	6-12	23+20	435x625x375	110	30	1900	100	Pure included	Wall mounted or floor standing*
Sense Combi Pure 10	10.5	10-18	23+20	435x625x375	110	30	1900	100	Pure included	Wall mounted or floor standing*
Sense Combi Elite 6	6,6	4-8	23+20	435x625x375	110	30	1900	100	Elite included	Wall mounted or floor standing*
Sense Combi Elite 8	8	6-12	23+20	435x625x375	110	30	1900	100	Elite included	Wall mounted or floor standing*
Sense Combi Elite 10	10.5	10-18	23+20	435x625x375	110	30	1900	100	Elite included	Wall mounted or floor standing*

## HOME ELECTRIC SAUNA HEATERS

Product	Output (kW)	Sauna volume (m³)	Weight heater + rocks (kg)	Size (WxHxD)	Safety distance				Suitable control panel	Installation
					Side (mm)	Front (mm)	Ceiling (mm)	Floor (mm)		
Crown Elite 6	6,6	4-8	25+20	360x360x800	50	30	1900		Elite included	Floor standing
Crown Elite 8	8	6-12	25+20	360x360x800	50	30	1900		Elite included	Floor standing
Crown Elite 10	10	10-18	25+20	360x360x800	50	30	1900		Elite included	Floor standing
Sense Pure 6	6,6	4-8	17+20	435x605x375	110	30	1900	100	Pure included	Wall mounted or floor standing*
Sense Pure 8	8	6-12	17+20	435x605x375	110	30	1900	100	Pure included	Wall mounted or floor standing*
Sense Pure 10	10,5	10-18	17+20	435x605x375	110	30	1900	100	Pure included	Wall mounted or floor standing*
Sense Elite 6	6,6	4-8	17+20	435x605x375	110	30	1900	100	Elite included	Wall mounted or floor standing*
Sense Elite 8	8	6-12	17+20	435x605x375	110	30	1900	100	Elite included	Wall mounted or floor standing*
Sense Elite 10	10,5	10-18	17+20	435x605x375	110	30	1900	100	Elite included	Wall mounted or floor standing*

## HOME ELECTRIC SAUNA HEATERS

Product	Output (kW)	Sauna volume (m³)	Weight heater + rocks (kg)	Size (WxHxD)	Safety distance				Suitable control panel	Installation
					Side (mm)	Front (mm)	Ceiling (mm)	Floor (mm)		
Sense Sport 2/4	2.2-4,5	2-4	9,3+7	348x480x214	20	30	1900	170	Built-in	Wall mounted
Sense Sport 6	6,6	4-8	17+20	435x605x375	110	30	1900	100	Built-in	Wall mounted or floor standing*
Sense Sport 8	8	6-12	17+20	435x605x375	110	30	1900	100	Built-in	Wall mounted or floor standing*

\*Feet for floor standing are bought separately.

## STEAM GENERATORS

Model	Item no.	Output (kW)	Steam room's min./max. volume (m³)				Steam production (kg/h)	Size in mm (LxWxH)	Suitable control panel
			Light wall made of glass, plastic, etc.		Heavy wall made of tiles, concrete, stone, etc.				
			With ventilation	Without ventilation	With ventilation	Without ventilation			
Steam Home	66210120	3 6 9	- 3-8 6-16	max. 3 4-15 13-24	- 2-5 4-10	max. 2 2,5-8 7-16	3,5 8 12	480 x 350 x 159	Elite + Pure

To be installed away from steam in a dry and vented space.

# Commercial heaters

## COMMERCIAL ELECTRIC SAUNA HEATERS

Product	Output (kW)	Sauna volume (m³)	Weight heater + rocks (kg)	Size (WxHxD)	Safety distance		Safety distance			Suitable control panel	Installation
					Side (mm)	Front (mm)	Ceiling (mm)	Floor (mm)			
Sense Commercial 6	6.6	4-8	16+20	431x559x375	110			1900		Pure or Elite with relay box Commercial Lite	Wall mounted or floor standing*
Sense Commercial 8	8	6-12	16,5+20	431x559x375	110			1900		Pure or Elite with relay box Commercial Lite	Wall mounted or floor standing*
Sense Commercial 10	10.7	10-18	32+25	650x650x400	150			1900		Pure or Elite with relay box Commercial Lite	Wall mounted
Sense Commercial 16	16	15-35	32+25	650x650x400	150			2100		Pure or Elite with relay box Commercial	Wall mounted
Sense Commercial 16 3x230V	16	15-35	32+25	650x650x400	150			2100		Pure or Elite with relay box Commercial	Wall mounted
Sense Commercial 20	20	22-43	32+25	650x650x400	150			2100		Pure or Elite with relay box Commercial	Wall mounted
Sense Commercial 20 3x230V	20	22-43	32+25	650x650x400	150			2100		Pure or Elite with relay box Commercial	Wall mounted

\*Feet for floor standing are bought separately.

## TYLARIUM

Sauna volume m³	Sauna heater kW	Relay box	Steam generator kW	Control panel	Required	Optional
10-18	Sense Commercial 10	Commercial Lite	Steam Commercial 9	Elite	Tylarium Elite Kit Item no. 71016000	Steam Distributor Commercial 90029263
15-35	Sense Commercial 16	Commercial	Steam Commercial 9	Elite	Tylarium Elite Kit Item no. 71016000	Steam Distributor Commercial 90029263
22-43	Sense Commercial 20	Commercial	Steam Commercial 12	Elite	Tylarium Elite Kit Item no. 71016000	Steam Distributor Commercial 90029263

## COMMERCIAL

Size of sauna room for professional use with corresponding heater output effect in kilowatts (kW)\*

Heater model	4-8 m³	6-12 m³	10-18 m³	15-35 m³	22-43 m³
Sense Commercial 6	6.6				
Sense Commercial 8		8.0			
Sense Commercial 10			10.7		
Sense Commercial 16				16.0	
Sense Commercial 20					20.0

\* Note: if your sauna room's walls have tiles, stones or glass add 1,5 m³ to your sauna room's volume for every m² of 'heavy material'.

## STEAM GENERATORS

Model	Item no.	Output (kW)	Steam room's min./max. volume (m³)				Steam production (kg/h)	Size in mm (LxWxH)	Suitable control panel
			Light wall made of glass, plastic, etc.		Heavy wall made of tiles, concrete, stone, etc.				
			With ventilation	Without ventilation	With ventilation	Without ventilation			
Steam Commercial	66210010	9	6-16	13-24	4-10	7-16	12	585 x 415 x 230	Elite + Pure
	66210015	12	14-22	22-30	8-15	14-20	16		
	66210020	15	18-25	28-38	10-19	18-25	20		
2 x 9 2 x 12 2 x 15 Steam Commercial		18	20-30	28-40	13-20	18-30	24		Elite
		24	28-40	38-50	18-30	28-40	32		
		30	36-50	56-76	32-42	42-57	40		
3 x 9 3 x 12 3 x 15 Steam Commercial		27	38-45	46-60	28-40	38-52	36		Elite
		36	43-60	58-70	38-50	48-60	48		
		45	54-75	84-114	47-63	60-75	60		

To be installed away from steam in a dry and vented space.

# Technical information & drawings

## Panacea p. 72-73

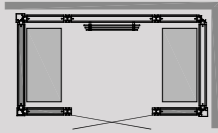

**PANACEA 1709**  
Size: 1725 x 925 x 2090 mm

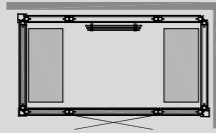

**PANACEA 1709 T**  
Size: 1725 x 925 x 2090 mm

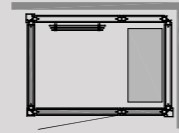

**PANACEA 1309 T**  
Size: 1325 x 925 x 2090 mm

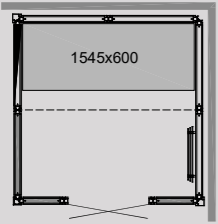

**PANACEA 1717 1B**  
1725 x 1725 x 2090 mm

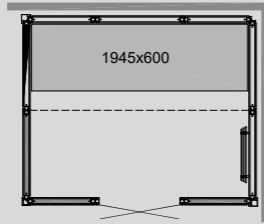

**PANACEA 2117 1B**  
2125 x 1725 x 2090 mm

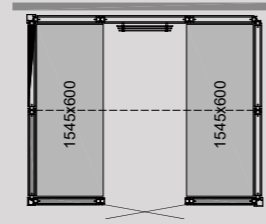

**PANACEA 2117 2B**  
2125 x 1725 x 2090 mm

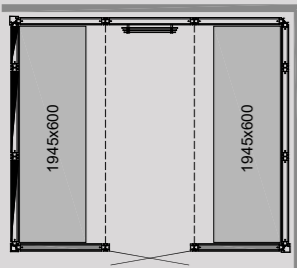

**PANACEA 2521 2B**  
Size: 2525 x 2125 x 2090 mm

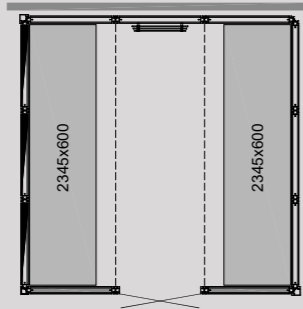

**PANACEA 2525 2B**  
2525 x 2525 x 2090 mm

1717, 2117 and 2525 can be delivered with a handicap-friendly door (930 mm opening).

## Panacea Twin p. 98-99

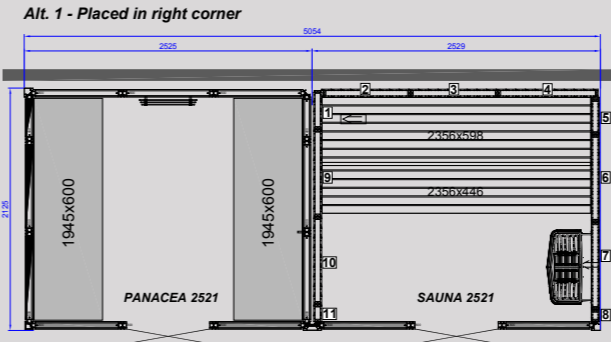

**TWIN PANACEA 2521**  
Size: D 2125 x W 5054 mm

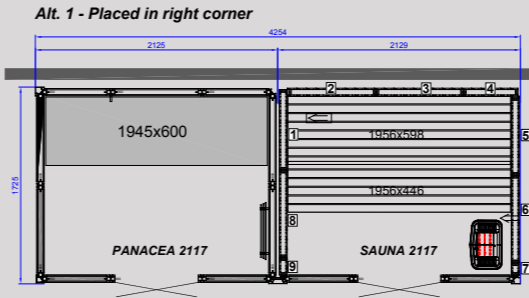

**TWIN PANACEA 2117**  
Size: D 1725 x W 4254 mm

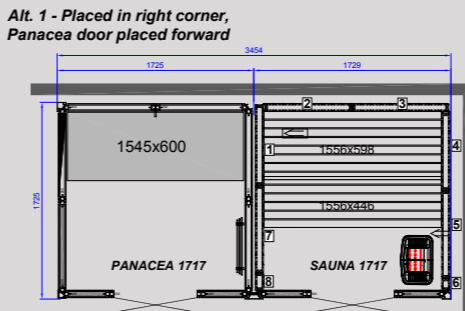

**TWIN PANACEA 1717**  
Size: D 1725 x W 3454 mm

# Technical information & drawings

## Infrared p. 82-89

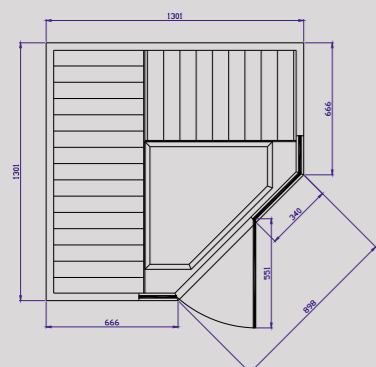

**TYLÖSAND T-870**  
Size: D 1 301 x W 1 301 mm  
Power: 1600 W

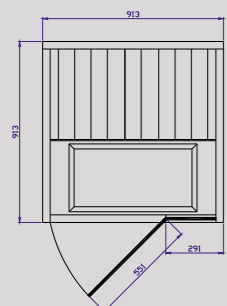

**TYLÖSAND T-810**  
Size: D 913 x W 913 mm  
Power: 1350 W

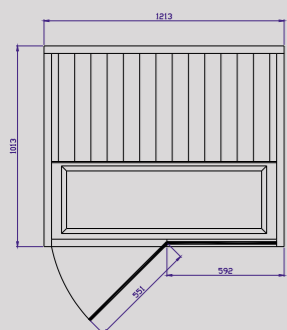

**TYLÖSAND T-820**  
Size: D 1 013 x W 1 213 mm  
Power: 1470 W

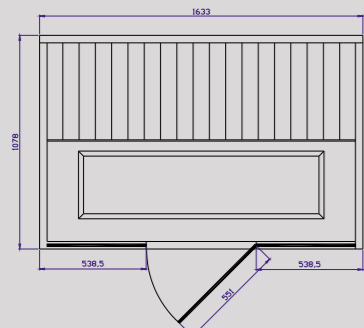

**TYLÖSAND T-825**  
Size: D 1 078 x W 1 633 mm  
Power: 1980 W

## Vista p. 68-69

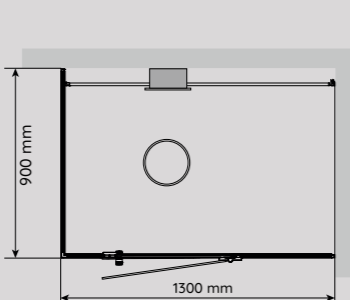

**VISTA 130 LEFT**  
Size: D 900 x W 1 300 mm

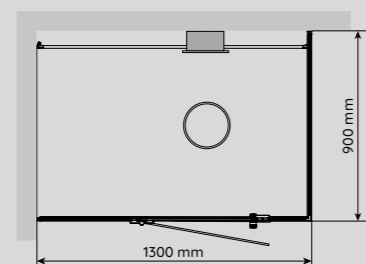

**VISTA 130 RIGHT**  
Size: D 900 x W 1 300 mm

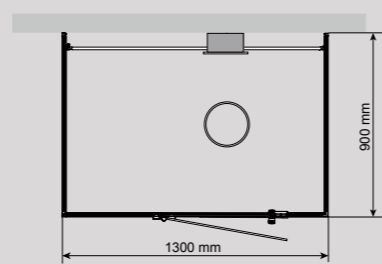

**VISTA DCO 130 RIGHT**  
Size: D 900 x W 1 300 mm

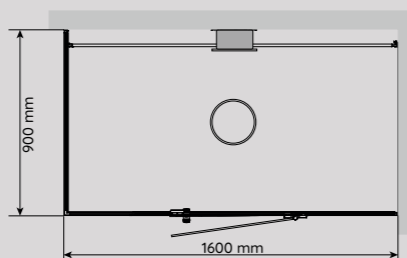

**VISTA 160 LEFT**  
Size: D 900 x W 1 600 mm

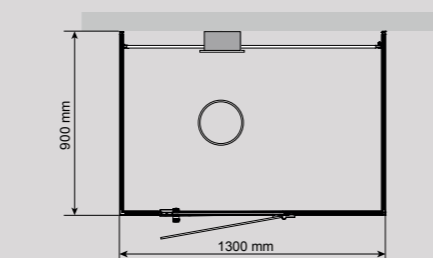

**VISTA DCO 130 LEFT**  
Size: D 900 x W 1 300 mm

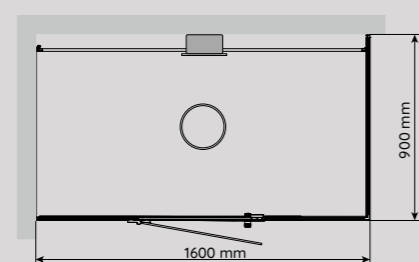

**VISTA 160 RIGHT**  
Size: D 900 x W 1 600 mm

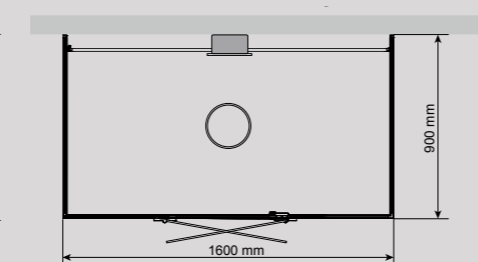

**VISTA DCO 160 (LEFT & RIGHT)**  
Size: D 900 x W 1 600 mm

## Reflection p. 12-15

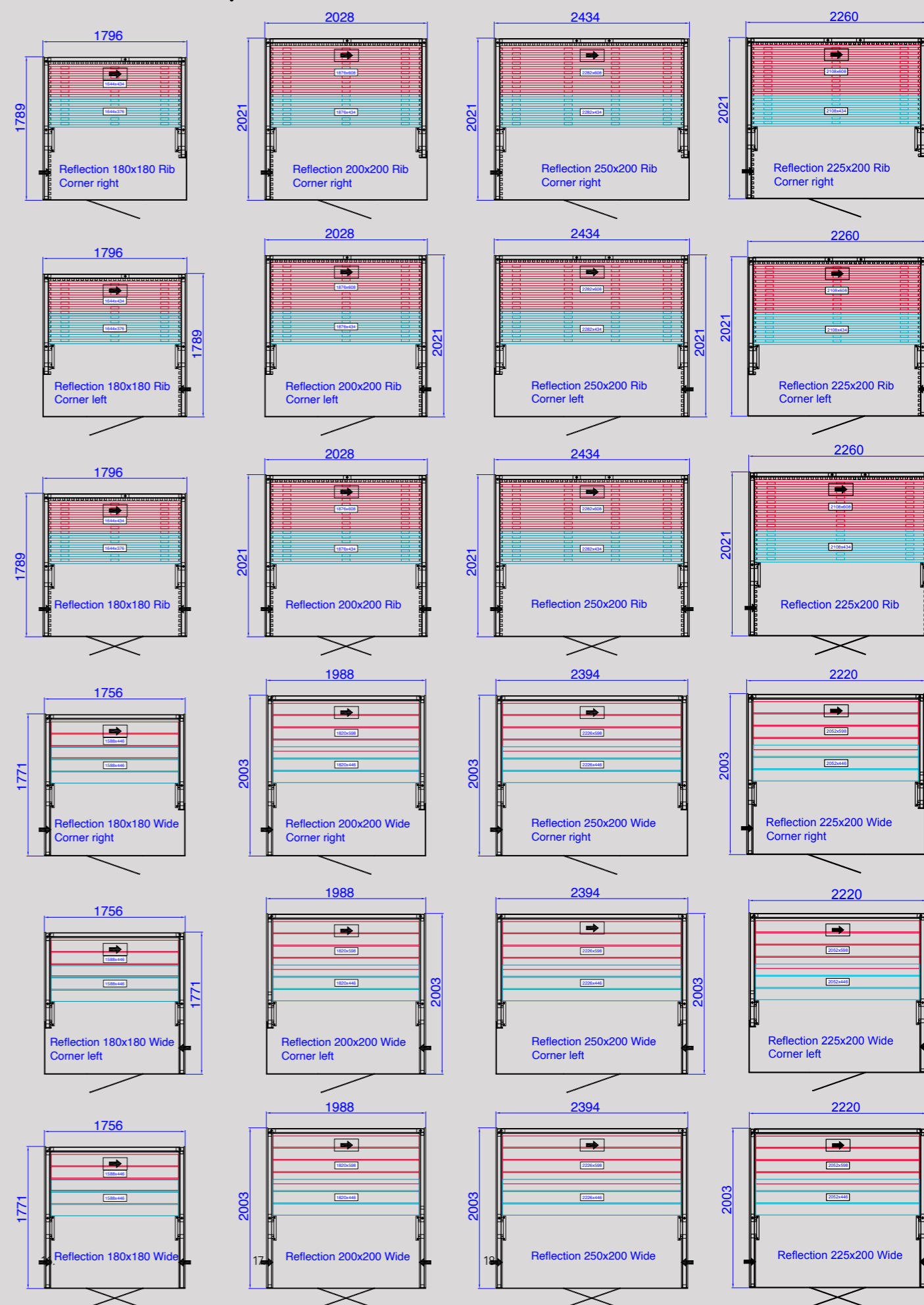



Over 75 years have passed since the Swedish founder of Tylö created his first sauna heater. We are proud of our heritage - solid traditions in craftsmanship, profound knowledge and Scandinavian legacy. Our passion is delivering top-quality sauna experiences - Soft Sauna and traditional saunas, steam baths, and soothing infrared warmth.

Enjoy your Tylö experience!



• Printed on Arctic Matt; FSC™ - The mark of responsible forestry • Print: Falkenberg Graphic Media AB • Layout: carolinegrantz.se